



**Dear VIZIO Customer,**

Congratulations on your new VIZIO VX37L High Definition LCD Television purchase. Thank you for your support. For maximum benefit of your set, please read these instructions before making any adjustments, and retain them for future reference. We hope you will experience many years of enjoyment from your new VIZIO VX37L High Definition Television.

**For assistance**, please call 714-668-0588 or e-mail us at [techsupport@vinc.com](mailto:techsupport@vinc.com).

To purchase or inquire about accessories and installation services for your VIZIO LCD HDTV, please visit our website at [www.VIZIO.com](http://www.VIZIO.com) or call toll free at **888-VIZIOCE (888-849-4623)**.

We recommend you register your VIZIO VX37L HDTV10A either at our website [www.VIZIO.com](http://www.VIZIO.com) or fill in your registration card and mail it in. For peace of mind and to protect your investment beyond the standard warranty, VIZIO offers on-site extended warranty service plans. These plans give additional coverage during the standard warranty period. Visit our website or call us to purchase a plan.

Write down the serial number located on the back of your VX37L.

-----

Purchase Date \_\_\_\_\_

*VIZIO is a registered trademark of V, Inc.*

*HDMI logo and "High Definition Multimedia Interface" are registered trademarks of HDMI Licensing LLC.*



## THIS PRODUCT HAS BEEN DESIGNED AND TESTED FOR COMPLIANCE WITH REGULATORY SAFETY CERTIFICATIONS

This product is designed and manufactured to operate within defined design limits, and misuse may result in electric shock or fire. To prevent the product from being damaged, the following rules should be observed for the installation, use and maintenance of the product. Read the following safety instructions before operating the display. Keep these instructions in a safe place for future reference.

- To avoid the risk of electric shock or component damage, switch off the power before connecting other components to the VX37L LCD HDTV.
- Unplug the power cord before cleaning the VX37L LCD HDTV. A damp cloth is sufficient for cleaning the VX37L LCD HDTV. Do not use a liquid or a spray cleaner for cleaning the product. Do not use abrasive cleaners.
- Always use the accessories recommended by the manufacturer to insure compatibility.
- When moving the VX37L LCD HDTV from an area of low temperature to an area of high temperature, condensation may form on the housing. Do not turn on the VX37L LCD HDTV immediately after this to avoid causing fire, electric shock or component damage.
- Do not place the VX37L LCD HDTV on an unstable cart, stand, or table. If the VX37L LCD HDTV falls, it can injure a person and cause serious damage to the appliance. Use only a cart or stand recommended by the manufacturer or sold with the VX37L LCD HDTV.
- A distance of at least 3 feet should be maintained between the VX37L LCD HDTV and any heat source, i.e. radiator, heater, oven, amplifier etc. Do not install the product close to smoke. Operating the product close to smoke or moisture may cause fire or electric shock.
- Slots and openings in the back and bottom of the cabinet are provided for ventilation. To ensure reliable operation of the VX37L LCD HDTV and to protect it from overheating, be sure these openings are not blocked or covered. Do not place the VX37L LCD HDTV in a bookcase or cabinet unless proper ventilation is provided.
- Never push any object into the slot on the VX37L LCD HDTV cabinet. Do not place any objects on the top of the product. It could short circuit parts causing a fire or electric shock. Never spill liquids on the VX37L LCD HDTV.
- The VX37L LCD HDTV should be operated only from the type of power source indicated on the label. If you are not sure of the type of power supplied to your home, consult your dealer or local power company.
- The power cable must be replaced when using different voltage from that specified in the User Manual. For more information, contact your dealer.
- The VX37L LCD HDTV is equipped with a **three-pronged grounded plug, a plug with a third (grounding) pin**. This plug will fit only into a grounded power outlet as a safety feature. If your outlet does not accommodate the three-wire plug, have an electrician install the correct outlet, or use an adapter to ground the appliance safely. **Do not defeat the safety purpose of the grounded plug.**
- Do not overload power strips and extension cords. Overloading can result in fire or electric shock.
- The wall socket shall be installed near the equipment and shall be easily accessible.
- Only the marked power source can be used for the product. Any power source other than the specified one may cause fire or electric shock.
- Do not touch the power cord during lightning. To avoid electric shock, avoid handling the power cord during electrical storms.
- Unplug the unit during a lightning storm or when it will not be used for long period of time. This will protect the VX37L LCD HDTV from damage due to power surges.
- Do not attempt to repair or service the product yourself. Opening or removing the back cover may expose you to high voltages, the risk of electric shock, and other hazards. If repair is required, please contact your dealer and refer all servicing to qualified service personnel.
- Keep the product away from moisture. Do not expose this appliance to rain or moisture. If water penetrates into the product, unplug the power cord and contact your dealer. Continuous use in this case may result in fire or electric shock.
- Do not use the product if any abnormality occurs. If any smoke or odor becomes apparent, unplug the power cord and contact your dealer immediately. Do not try to repair the product yourself.
- Avoid using dropped or damaged appliances. If the product is dropped and the housing is damaged, the internal components may function abnormally. Unplug the power cord immediately and contact your dealer for repair. Continued use of the product may cause fire or electric shock.
- Do not install the product in an area with heavy dust or high humidity. Operating the product in environments with heavy dust or high humidity may cause fire or electric shock.
- Follow instructions for moving the product. Ensure that the power connector and any other cables are unplugged before moving the product.
- Hold the power connector when removing the power cable. Pulling the power cable itself may damage the wires inside the cable and cause fire or electric shock. When the product will not be used for an extended period of time, unplug the power connector.
- To avoid risk of electric shock, do not touch the connector with wet hands.
- Insert batteries in accordance with instructions. Incorrect polarities may cause damage and leakage of the batteries, operator injury and contamination the remote controller.
- If any of the following occurs please contact the dealer:
  - The power connector fails or frays.
  - Liquid sprays or any object drops into the VX37L LCD HDTV.
  - The Display is exposed to rain or other moisture.
  - The Display is dropped or damaged in any way.
  - The performance of the Display changes substantially.



## Television Antenna Connection Protection

### External Television Antenna Grounding

If an outside antenna/satellite dish or cable system is to be connected to the TV, make sure that the antenna or cable system is electrically grounded to provide some protection against voltage surges and static charges.

Article 810 of the National Electrical Code, ANSI/NFPA 70, provides information with regard to proper grounding of the mast and supporting structure, grounding of the lead-in wire to an antenna discharge unit, size of the grounding conductors, location of antenna discharge unit, connection to grounding electrodes, and requirements of the grounding electrode.

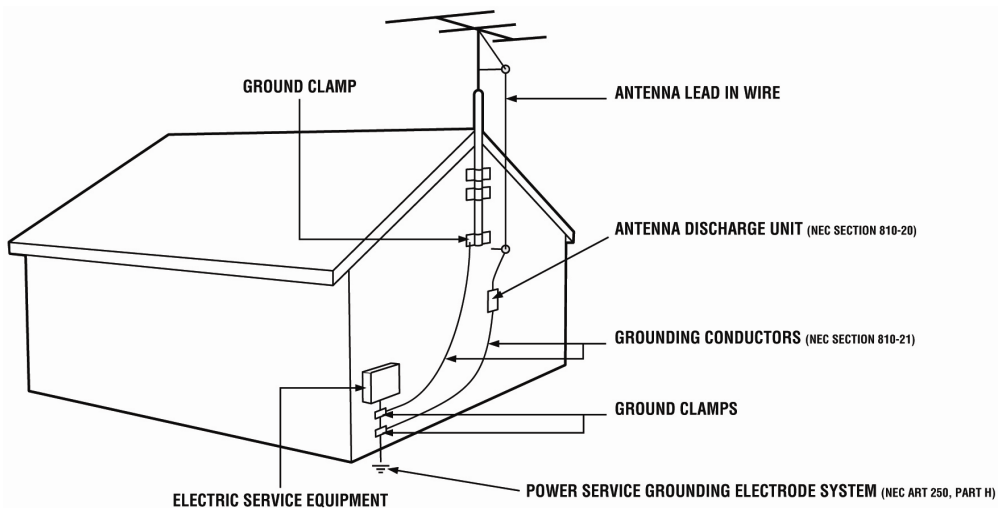

### Lightning Protection

For added protection of the TV during a lightning storm or when it is left unattended or unused for long periods of time, unplug the TV from the wall outlet and disconnect the antenna or cable system.

### Power Lines

Do not locate the antenna near overhead light or power circuits, or where it could fall into such power lines or circuits.

**Remember, the screen of the coaxial cable is intended to be connected to earth in the building installation.**



## Opening the Package

Your VIZIO VX37L HDTV10A and its accompanying accessories are carefully packed in a cardboard carton that has been designed to protect it from transportation damage. Now you have opened the carton, check that the VX37L HDTV10A is in good condition and that all of the accessories are included.

The VX37L HDTV10A weighs approximately 44lb and is over 36" wide; we advise that you have at least 2 people to unpack and install the HDTV.

The screen can easily be scratched or broken, so please handle the product gently and never place the HDTV with the glass facing downwards on a surface without protective padding.

**IMPORTANT:** Save the carton and packing material for future shipping.

## Package Contents

VIZIO VX37L HDTV10A  
VIZIO Remote Control  
AV Cable (Yellow, Red and White Connectors)  
Power Cord  
VIZIO Bezel and Screen Cleaning Cloth  
Quick Setup Guide  
Registration Card  
VIP Services Brochure



## Additional Certified Accessories for the VIZIO VX37L HDTV10A are sold separately

Wall Mounts  
High Definition Cables  
Extra or replacement Remote

VIZIO also offers Installation Services and Extended Warranty Services for your VIZIO VX37L HDTV10A

To purchase or inquire about additional accessories and services for your VIZIO product, visit our web site at [www.VIZIO.com](http://www.VIZIO.com) or call us toll free at 888-VIZIOCE (888-849-4623)



## Installation Preparation

Please read this user manual carefully before installing your VIZIO HDTV.

The power consumption of the TV is about 210W, please use the power cord designated for TV. When an extension cord is required, use one with the correct power rating. The cord must be grounded and the grounding feature must not be defeated.

The TV should be installed on a flat surface to avoid tipping. For proper ventilation, you must allow space between the back of the TV and the wall. If you would like to mount your TV on the wall, please see below 'Preparing Your LCD HDTV for Wall Mounting' for additional information. Avoid installing the TV in places with high humidity, dust or smoke so as not to shorten the service life of the electronic components. Install the TV in landscape orientation; any 90° clockwise or counter-clockwise installation may induce poor ventilation and excessive component damage.

VIZIO offers professional installation services. Please contact VIZIO for more information on these services at 888-VIZIOCE (888-849-4623) or [www.VIZIO.com](http://www.VIZIO.com).

## Preparing Your LCD HDTV for Wall Mounting

The VIZIO VX37L can either be kept on the stand base or mounted on the wall for viewing. If you choose to mount the VX37L on the wall, please follow the instructions below for removing the stand base.

### To remove the stand base

1. Unplug all of the cables and cords from your VX37L.
2. Place the VX37L face down on a soft and flat surface (blanket, foam, cloth, etc) to prevent any damage to the TV.
3. Remove the eight (8) screws holding the base to the VX37L.
4. Carefully remove the stand base.

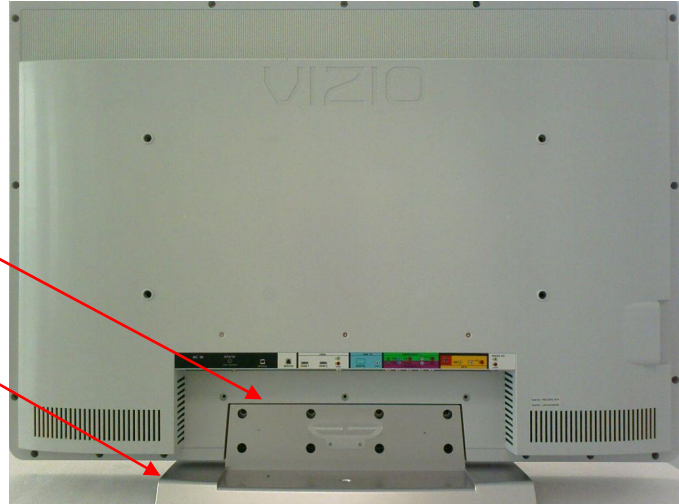

To find the perfect mount for the VIZIO VX37L, browse VIZIO's certified mount selection at [www.VIZIO.com](http://www.VIZIO.com) or call directly 888-VIZIOCE (888-849-4623).



# Table of Contents

- Chapter 1 Basic Controls and Connections ..... 8**
  - 1.1 Front Panel ..... 8
  - 1.2 Right Side Panel Controls ..... 8
  - 1.3 Left Side Connections ..... 8
  - 1.4 Rear Panel Connections ..... 9
  - 1.5 VIZIO Remote Control ..... 10
    - 1.5.1 Insertion of Batteries in the Remote Control ..... 12
    - 1.5.2 Remote Control Range ..... 12
    - 1.5.3 VIZIO Remote Control Precautions ..... 12
- Chapter 2 Connecting Equipment ..... 13**
  - 2.1 Which Video Connection Should I Use? ..... 13
  - 2.2 Connecting Your DVD Player ..... 14
    - 2.2.1 Using HDMI ..... 14
    - 2.2.2 Using Component Video ..... 15
    - 2.2.3 Using S-Video (AV1) ..... 16
    - 2.2.4 Using Composite (AV) Video ..... 16
  - 2.3 Connecting Your HDTV Set-Top Box ..... 17
    - 2.3.1 Using HDMI ..... 17
    - 2.3.2 Using Component Video ..... 19
  - 2.4 Connecting Your Basic Set-Top Box ..... 20
    - 2.4.1 Using Composite Video ..... 20
    - 2.4.2 Using Coax (RF) ..... 20
  - 2.5 Connecting Your VCR or Video Camera ..... 21
  - 2.6 Connecting Coaxial (RF) ..... 21
    - 2.6.1 Using Your Antenna or Digital Cable for DTV ..... 21
    - 2.6.2 Using Your Antenna or Cable for TV ..... 22
    - 2.6.3 Using the Antenna or Cable through your VCR ..... 22
  - 2.7 Connecting a PC Computer ..... 23
    - 2.7.1 Preset PC Resolutions ..... 23
- Chapter 3 Setting Up to Watch Television ..... 24**
  - 3.1 Basic LCD HDTV Start Up ..... 24
  - 3.2 Using a PC ..... 26
  - 3.3 Watching a TV Program ..... 27
  - 3.4 Adjusting Basic HDTV Settings ..... 27
  - 3.5 Program Information ..... 28
  - 3.6 Information on HDTV Status ..... 28
- Chapter 4 Advanced Adjustment of HDTV ..... 29**
  - 4.1 Using the On Screen Display (OSD) ..... 29
  - 4.2 DTV / TV Input Picture Adjustment ..... 30
    - 4.2.1 Picture Mode ..... 30
    - 4.2.2 Backlight ..... 30
    - 4.2.3 Brightness ..... 31
    - 4.2.4 Contrast ..... 31
    - 4.2.5 Color ..... 31
    - 4.2.6 Tint ..... 31
    - 4.2.7 Sharpness ..... 32
    - 4.2.8 Color Temperature ..... 32
    - 4.2.9 Advanced Video ..... 33
  - 4.3 DTV / TV Input Audio Adjustment ..... 34
    - 4.3.1 Volume ..... 34
    - 4.3.2 Bass ..... 34
    - 4.3.3 Treble ..... 34
    - 4.3.4 Balance ..... 34
    - 4.3.5 Surround ..... 35
    - 4.3.6 Speakers ..... 35
  - 4.4 DTV / TV Tuner Setup ..... 35
    - 4.4.1 Tuner Mode ..... 35
    - 4.4.2 Auto Search ..... 35
    - 4.4.3 Skip Channel ..... 35



4.4.4 Time Zone .....	36
4.4.5 Daylight Saving.....	36
4.5 DTV / TV Input Setup .....	36
4.5.1 Language.....	36
4.5.2 Sleep Timer .....	36
4.5.3 Analog Closed Caption .....	36
4.5.4 Digital Closed Caption .....	36
4.5.5 Digital Closed Caption Style .....	37
4.5.6 Reset All Settings .....	37
4.6 DTV / TV Input Parental Control.....	38
4.6.1 Channel Block .....	38
4.6.2 TV Rating.....	39
4.6.3 Movie Rating.....	39
4.6.4 Blocked Unrated Programming.....	40
4.6.5 Change the Password .....	40
4.7 HDMI Input Picture Adjustment .....	41
4.8 HDMI Input Audio Adjustment .....	41
4.9 HDMI Input Setup.....	41
4.10 Video Input Picture Adjustment .....	42
4.11 Video Input Audio Adjustment .....	42
4.12 Video Input Setup.....	42
4.13 Video Input Parental Control .....	43
4.14 PC Input Picture Adjustment .....	43
4.14.1 Auto Adjust .....	43
4.14.2 Backlight .....	43
4.14.3 Brightness.....	43
4.14.4 Contrast.....	44
4.14.5 Color Temperature.....	44
4.14.6 H-SIZE.....	45
4.14.7 H. Position .....	45
4.14.8 V. Position .....	45
4.14.9 Fine Tune .....	45
4.15 PC Input Audio Adjustment .....	45
4.16 PC Input Setup.....	45
4.17 Understanding Viewing Features .....	46
4.17.1 Viewing Modes .....	46
4.17.2 Picture-In-Picture(PIP) Mode.....	47
4.17.3 Adjusting Basic PIP Settings .....	47
4.17.4 Setting the Sleep Timer .....	48
4.18 Using a Cable or Satellite Remote .....	48
<b>Chapter 5 Maintenance and Troubleshooting.....</b>	<b>49</b>
5.1 Maintenance.....	49
5.2 Troubleshooting Guide.....	49
5.3 Telephone & Technical Support .....	51
5.4 Compliance .....	52
5.5 FCC Class B Radio Interference Statement.....	52
<b>Chapter 6 Miscellaneous Information .....</b>	<b>53</b>
6.1 Specifications .....	53
6.2 Glossary – Standard Definitions .....	54
6.3 Index .....	55
6.4 Limited Product Warranty.....	57
6.4.1 VIZIO Extended Service Warranty.....	57



# Chapter 1 Basic Controls and Connections

## 1.1 Front Panel

**Power 'VIZIO' light** – The VIZIO name lights white when powered on and orange when powered off.

**Remote Control Sensor** – This is the window through which all of the remote control signals pass to the sensor. Point the remote control directly at this window for the best response to the remote signal.

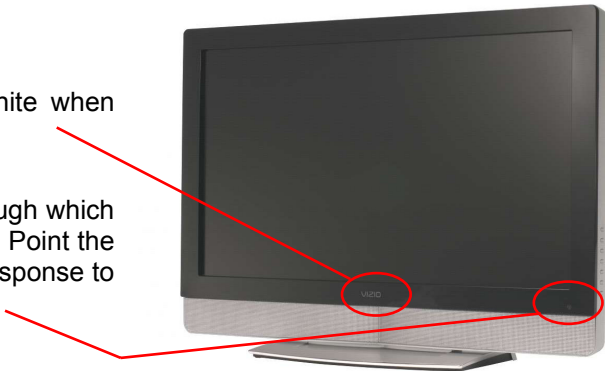

## 1.2 Right Side Panel Controls

**Power** (  ) – Switch the VX37L on by pressing the button once. Press the button again to the VX37L off.

**Menu** – This button activates the On Screen Display (OSD). If a sub-menu is active, pressing this button will return to the previous menu level.

**Channel ▲/▼** – Use these buttons to step up or down the TV channels. While the OSD is active, these buttons function as up and down controls in the OSD menus.

**Volume ◀/▶** – Use these buttons to increase or decrease to the speaker volume. While the OSD is active, these buttons function as left and right controls in the OSD menus.

**Input (Enter)** – Repeated pressing of this buttons steps through the input sources in the following sequence: TV, AV1 (S-Video or Video), AV2, Component 1, Component 2, HDMI 1, HDMI 2, and RGB. Once you have stepped through the entire sequence, you will return to the beginning.

Additionally, when the OSD is active, this button confirms the menu function to be adjusted. When the OSD is not active, pressing this button will display the current input mode.

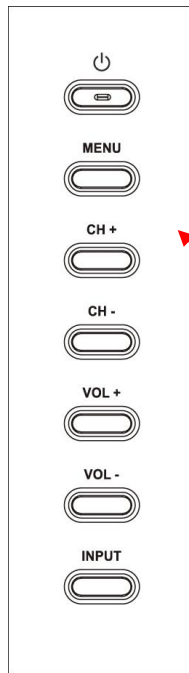

## 1.3 Left Side Connections

1. **AV1 In** – Connect the primary source for composite video devices, such as a VCR or video game. Use the white and red connectors to connect the external audio from the same source. The orange color band on the rear of the TV indicates this connection. The S-Video, if connected, will take priority over AV1 RCA connector.





## 1.4 Rear Panel Connections

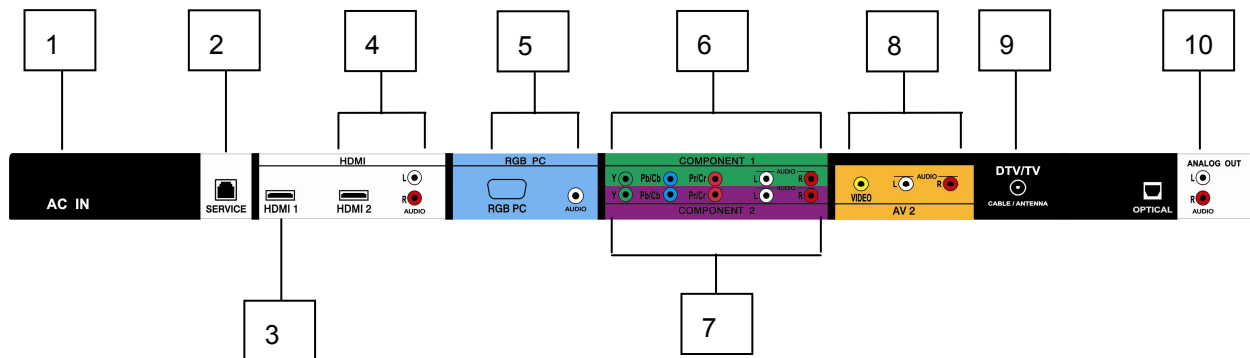

1. **AC IN** – Plug-in the supplied AC Power Cord here.
2. **SERVICE** – This custom communication port is for factory service only.
3. **HDMI 1** – Connect the primary source for digital video such as a DVD multimedia player or set top box through this all digital connector. The white color band on the rear of the TV indicates this connection. Your VIZIO Certified HDMI cables are available for purchase from [www.VIZIO.com](http://www.VIZIO.com) or by calling 888-VIZIOCE (888-849-4623).
4. **HDMI 2** – Connect the secondary source for digital video such as a DVD multimedia player or set top box through this all digital connector. The white color band on the rear of the TV indicates this connection. For users who want to connect to a DVI enabled device, use a DVI-HDMI cable and connect the Analog Audio output of the device to the L+R AUDIO here. Your VIZIO Certified HDMI and HDMI-DVI cables are available for purchase from [www.VIZIO.com](http://www.VIZIO.com) or by calling 888-VIZIOCE (888-849-4623).
5. **RGB PC** – Connect the video and audio from a computer here. The blue color band on the rear of the TV indicates this connection.
6. **COMPONENT 1 (YPb/CbPr/Cr with Audio L/R)** – Connect the primary source for component video devices such as a DVD Player or set top box here. From left to right, use green for Y, blue for Pb (or Cb), red for Pr (or Cr), white for left audio and red for right audio inputs. The green color band on the rear of the TV indicates this connection.
7. **COMPONENT 2 (YPb/CbPr/Cr with Audio L/R)** – Connect the secondary source for component video devices such as a DVD Player or set top box here. From left to right, use green for Y, blue for Pb (or Cb), red for Pr (or Cr), white for left audio and red for right audio inputs. The purple color band on the rear of the TV indicates this connection.
8. **AV2 In** – Connect the secondary source for composite video devices, such as a VCR or video game. Use the white and red connectors to connect the external audio from the same source. The orange color band on the rear of the TV indicates this connection.
9. **DTV** – Connect to an antenna or digital cable (out-of-the-wall, not from Cable Box) for Digital TV.\*
10. **Audio Out** – Connect the audio from the LCD HDTV to an external device, such as a home theatre system, external amplifier or stereo. Speakers cannot be connected directly to here. The gray color band on the rear of the TV indicates this connection.

\* For digital TV stations in your area visit [www.antennaweb.org](http://www.antennaweb.org).



## 1.5 VIZIO Remote Control

**Remote LED** – Blinks when the remote operates.

**POWER** – Press this button to turn the TV on from the Standby mode. Press it again to return to the Standby mode.

**Number Button Pad** – Use these buttons to select a channel or enter a password.

**INPUT** – This button allows the user to cycle through the inputs.

- **(Dash)** – When selecting a digital channel directly use this button for the separation of main and sub-channels. For example, channel 28-2 would be selected by the button sequence 2 8 ENTER 2.

**CH (+ or -)** – These buttons change the channels up or down.

**LAST** – This button recalls the previously viewed channel.

**MUTE** – This button turns the sound on and off. **VOL (+ or -)** – These buttons turn the volume up or down.

**MENU** – Use this button for the On-Screen Display (OSD) menus.

**INFO** – This button displays the image and system information display.

**GUIDE** – This button displays program information. *Note: this button is only functional for DTV.*

**EXIT** – This button exits the On-Screen Display (OSD) menus.

 - These buttons navigate the On-Screen Display (OSD).

**OK** – Use this button to select your chosen option in On-Screen Display (OSD) menus.



**NOTE:** Your Remote Control may look like this.



**WIDE** – This button cycles through the available screen formats. The options for SD (Standard Definition 4:3) are Normal, Zoom and Panoramic. . The options for HD (High Definition 16:9) and RGB PC are Normal and Zoom.

**SLEEP** – This button allows the user to select the sleep options by adjusting the timer for 30, 60, 90 or 120 minutes.

**MTS** – This button will select the MTS options of Stereo, SAP or Mono in TV mode and alternate audio channels, where available, in DTV mode.

**CC** – This button will select the Closed Caption mode. The options are OFF, CC1, CC2, CC3 or CC4.

**TV** – Press this button to select TV.

**AV** – Repeated pressing of this button with switch between AV-C (Composite, yellow RCA) and AV-S (S-Video) inputs.

**COMPONENT** – Press this button to select the Component (YPbPr) input.

**HDMI** – Press this button to select the HDMI input.

**ZOOM (- and +)** – Use these buttons to increase or decrease the size of the picture. Note that in the zoom mode parts of the picture will not be visible because they extend beyond the edges of the screen.

**FREEZE** – Press this button to “Freeze-Frame” the current screen. Press this button again the continue playing.

**RGB** – This button selects an RGB Analog component such as a PC.

**PIP** – Use this button to activate the Picture-In-Picture mode.

**PIP CH (- and +)** – These buttons are used to select the channels within the PIP screen when DTV/TV is the PIP input selected.

**AUDIO** – Press this button to switch the audio from the main screen to the sub-screen while in PIP mode.

**PIP INPUT** – Press the button to choose the PIP input. Note: The TV must be in PIP mode for this button to be functional. For additional information regarding the PIP options, see section 4.17.2 - Picture-In-Picture (PIP) Mode, page 47.

**PIP SIZE** – Press this button to select the size of the PIP screen from one of the following: small, medium or large.

**MODE** – Use this button to change the picture mode from Custom, Standard, Movie and Game.

**SWAP** – Used to swap the inputs from the main screen and the sub-screen while in PIP mode.



### 1.5.1 Insertion of Batteries in the Remote Control

Insert two AA batteries into the remote control. Make sure that you match the (+) and (-) symbols on the batteries with the (+) and (-) symbols inside the battery compartment. Re-attach the battery cover.

Precautionary Tips for Inserting the Batteries:

Only use the specified AA batteries.

Do not mix new and old batteries. This may result in cracking or leakage that may pose a fire risk or lead to personal injury.

Inserting the batteries incorrectly may also result in cracking or leakage that may pose a fire risk or lead to personal injury.

Dispose of the batteries in accordance with local laws and regulations.

Keep the batteries away from children and pets.



### 1.5.2 Remote Control Range

Point the remote control at the remote control sensor to transmit the commands.

Do not place any obstacles between the remote control and the receiver window.

The effective range of the remote control is approximately 30 feet (10 meters) from the front of the receiver window, 30° to the left and right, 20° up and down.

### 1.5.3 VIZIO Remote Control Precautions

The remote control should be kept dry and away from heat sources. Avoid humidity.

If the TV responds erratically to the remote control or does not respond at all, check the batteries. If the batteries are low or exhausted, replace them with fresh batteries.

When not using the remote control for a long period of time, remove the batteries.

Do not take the batteries apart, heat them, or throw them into a fire.

Do not subject the remote control to undue physical stress, such as striking or dropping it.







Do not attempt to clean the remote control with a volatile solvent. Wipe it with a clean, damp cloth.

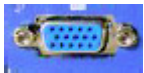

## Chapter 2 Connecting Equipment

### 2.1 Which Video Connection Should I Use?

The VIZIO VX37L has six different ways to connect your video equipment from a basic connection to the most advanced for digital displays.

Connection Quality (type)	Connector	Rear Panel Color Codes	Description
Best (digital)		White	HDMI (High-Definition Multimedia Interface) - It is the first and only industry-supported, uncompressed, all-digital audio/video interface. HDMI provides an interface between any audio/video source, such as a set-top box, DVD player, or A/V receiver and an audio and/or video monitor, such as a digital television (DTV), over a single cable.
Best (digital) ----- Good (analog)		Black	DTV Coaxial RF. When used for MPEG2 encoded bit streams from ATSC broadcast programming, this input takes advantage of the High Definition content. ----- TV Coaxial RF. This is the connection for standard NTSC TV using antenna or cable.
Best (analog)		Blue	RGB PC (VGA) – This video input has separate red, green and blue color components. The signal carries horizontal and vertical sync information on the green signal. This is most commonly used for PC input.
Better (analog)		Green and Purple	Component - The video signal is separated into three signals, one containing the black-and-white information and the other two containing the color information. This enhancement over S-Video takes advantage of the superior picture provided by progressive scan DVD players and HDTV formats.
Good (analog)		Red	S-Video (AV1) - The video signal is separated into two signals, one containing the black-and-white information and the other containing the color information. Separating the color in this way avoids 'cross color' effects where closely spaced black and white lines are erroneously displayed in color. It also enables text to be displayed more sharply.
Good (analog)		Yellow and Orange	Composite (AV1/2) - The complete video signal is carried through this single pin connector. This is the most commonly used video connection.

Note: For more info refer to the Quick Start Guide



## 2.2 Connecting Your DVD Player

You have several options for connecting your DVD player to your VX37L; HDMI, Component, AV (S-Video or Composite) inputs. Based on your configuration, you can decide which option is right for you.

### 2.2.1 Using HDMI

DVD players that have a digital interface such as HDMI (High Definition Multimedia Interface) should be connected to the HDMI input of the VIZIO VX37L for optimal results.

Note: To maintain the display quality, use a VIZIO certified HDMI cable available up to 10 meters. See [www.VIZIO.com](http://www.VIZIO.com) or call 1-888-VIZIOCE (1-888-849-4623) for details.

### Connecting your DVD Player (Best):

The image shows the rear panel of the VIZIO HDTV with various input ports. The HDMI 1 port is circled in red. Below the panel is a photograph of the HDTV with an HDMI cable plugged into the HDMI 1 port.

1. Turn off the power to the HDTV and DVD player.
2. Connect a HDMI cable to the HDMI output of your DVD player and the other end to the HDMI Input (white color area) at the rear of the HDTV.
3. Turn on the power to the HDTV and DVD player.
4. Select HDMI using the INPUT button on the remote or side of the HDTV, or directly by pressing the HDMI button on the Remote Control.

### For DVD Players with DVI:

The image shows the rear panel of the VIZIO HDTV with various input ports. The HDMI 2 port is circled in red. Below the panel is a photograph of the HDTV with an HDMI-DVI cable and an audio cable plugged into the HDMI 2 port.

1. Turn off the HDTV and DVD player.
2. Using a HDMI-DVI cable, connect the DVI end to your DVD player and the HDMI end to the HDMI Input (white color area) at the rear of the HDTV.
3. Connect an audio cable (white and red connectors) to the audio output connectors associated with the DVI output of the DVD player and connect the other end to the audio connectors by the HDMI input (white area) at the rear of the HDTV.
4. Turn on the power to the HDTV and your DVD player.
5. Select HDMI using the INPUT button on the remote or side of the HDTV, or directly by pressing the HDMI button on the Remote.

Note: Refer to your DVD player user manual for more information about the video output requirements of the product.



## 2.2.2 Using Component Video

### Connecting your DVD Player (Better):

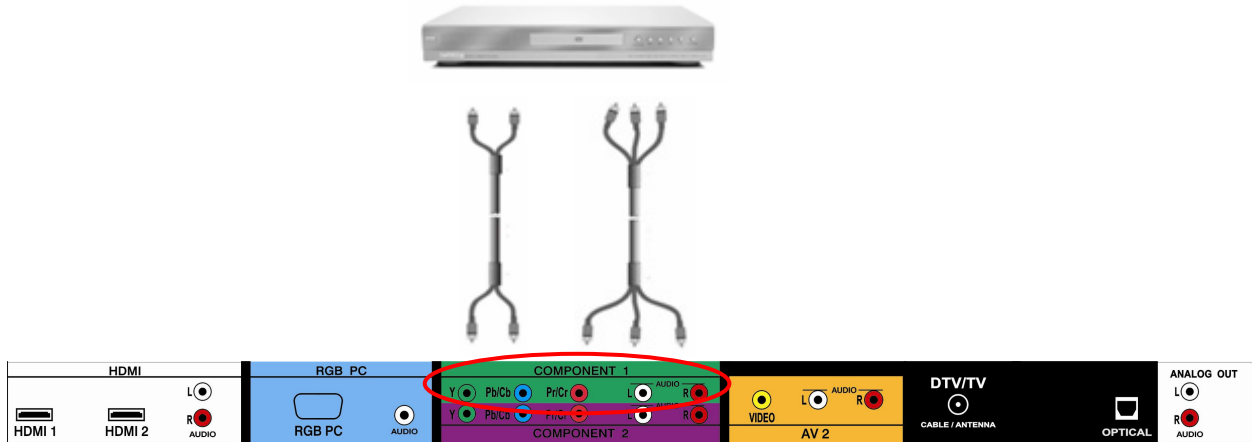

1. Turn off the power to the HDTV and DVD player.
2. Connect the Y (green color) connector on your DVD player to the corresponding Y (green color) connector in the Component 1 group (green color area - row of connectors nearest to you when viewing from the rear of the TV) at the rear of the HDTV.
3. Connect the Pb (blue color) connector on your DVD player to the corresponding Pb (blue color) connector in the Component 1 group (green color area - row of connectors nearest to you when viewing from the rear of the TV) at the rear of the HDTV.
4. Connect the Pr (red color) connector on your DVD player to the corresponding Pr (red color) connector in the Component 1 group (green color area - row of connectors nearest to you when viewing from the rear of the TV) at the rear of the HDTV.
5. Using an audio cable (white and red connectors), connect the cable to the audio output connectors associated with the Component output on your DVD player and connect the other end to the audio connectors associated with the Component 1 input (green color area) at the rear of the HDTV.
6. Turn on the power to the HDTV and DVD player.
7. Select Component using the INPUT button on the remote or side of the HDTV, or directly by pressing the Component button on the Remote Control.

Note: Refer to your DVD player user manual for more information about the video output requirements of the product.



### 2.2.3 Using S-Video (AV1) Connecting your DVD Player (Good):

1. Turn off the power to the HDTV and DVD player.
2. Connect the S-Video jack on the rear of your DVD player to the S-Video jack in the AV1 group on the side of the HDTV.
3. Connect an audio cable (white and red connectors) to the audio output connectors associated with the S-Video output on your DVD player and connect the other end to the audio connectors associated with the AV1 input on the side of the HDTV.
4. Turn on the power to the HDTV and DVD player.
5. Select AV1 using the INPUT button on the remote or side of the HDTV, or directly by pressing the AV button on the Remote Control.

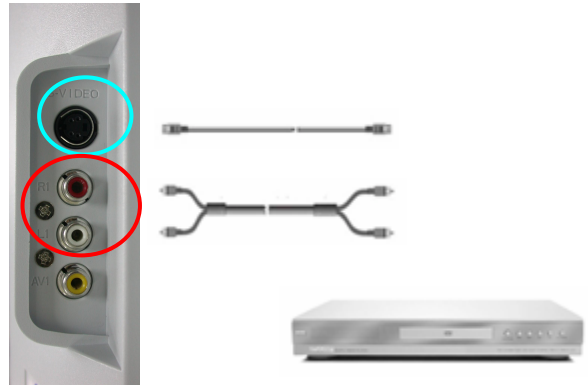

### 2.2.4 Using Composite (AV) Video Connecting your DVD Player (Good) :



1. Turn off the power to the HDTV and DVD player.
2. Connect the Video (yellow color) connector on your DVD player to the Video (yellow color) connector in the AV2 group (yellow color area).
3. Connect the R (red color) and L (white color) audio connectors on your DVD player to the corresponding R (red color) and L (white color) audio input connectors in the AV2 group (yellow color area).
4. Turn on the power to the HDTV and DVD Player.
5. Select AV2 using the INPUT button on the remote or side of the HDTV, or directly by pressing the AV button on the Remote Control.



**Note:**

- a) You may use the AV1 input on the side if you wish, as long as you are not already using it for the S-Video input.
- b) Refer to your DVD player user manual for more information about the video output requirements of the product.





## 2.3 Connecting Your HDTV Set-Top Box

### 2.3.1 Using HDMI

HDTV Set-Top Boxes that have a HDMI digital interface should be connected to the HDMI input of the LCD HDTV for optimal results.

Note: To maintain the display quality, use a VIZIO certified HDMI cable that is 10 meters. See [www.VIZIO.com](http://www.VIZIO.com) or call 1-888-VIZIOCE (1-888-849-4623) for details.

### Connecting your HDTV Set-Top Box (Best):

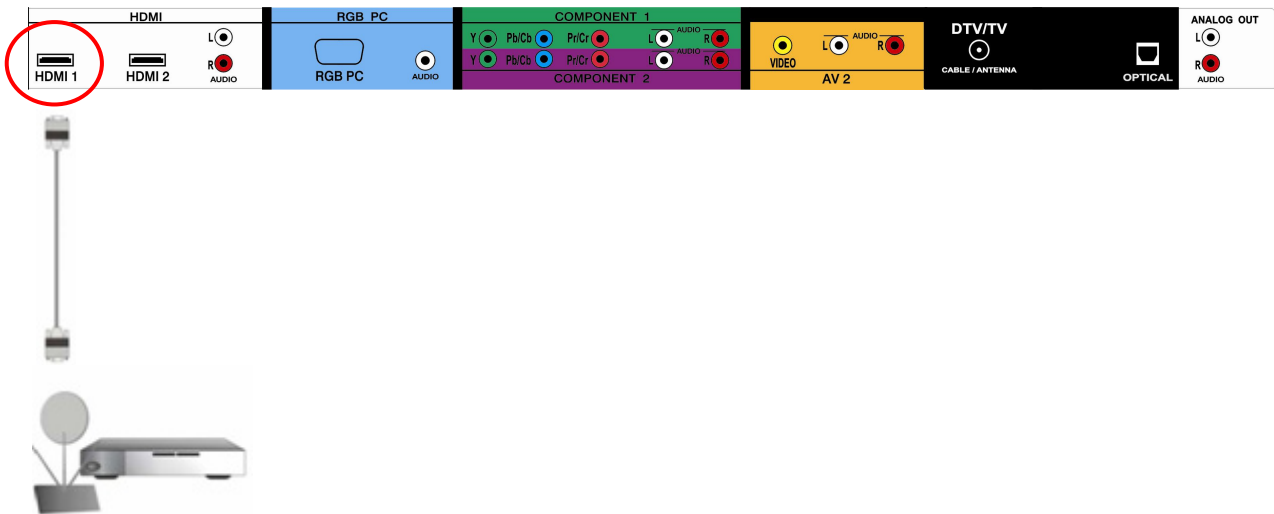

1. Turn off the power to the HDTV and HDTV Set-Top Box.
2. Connect a HDMI cable to the HDMI output of your HDTV Set-Top Box and the other end to the HDMI Input (white color area) at the rear of the HDTV.
3. Turn on the power to the HDTV and HDTV Set-Top Box.
4. Select HDMI using the INPUT button on the remote or side of the HDTV, or directly by pressing the HDMI button on the Remote Control.

Note:

- a) The HDMI input on the HDTV supports High-bandwidth Digital Content Protection (HDCP). HDCP encrypts the transmission between the video source and the digital display for added security and protection.
- b) Refer to your HDTV Set-Top Box user manual for more information about the video output requirements of the product or consult your cable or satellite operator.



## For HDTV Set-Top Boxes with DVI:

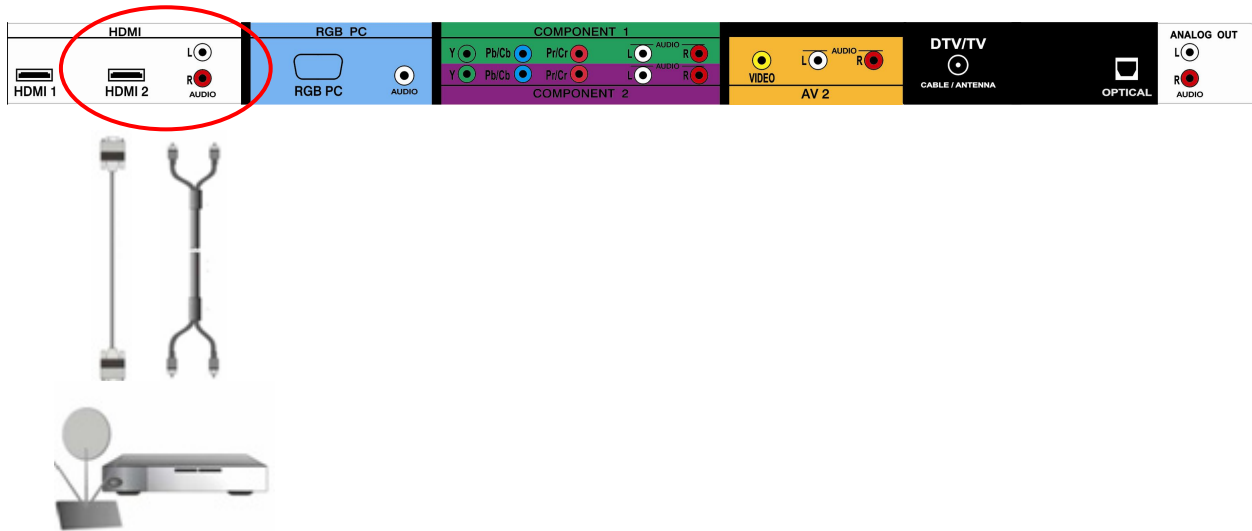

1. Turn off the power to the HDTV and HDTV Set-Top Box.
2. Using a HDMI-DVI cable, connect the DVI end to your HDTV Set-Top Box and the HDMI end to the HDMI Input (white color area) at the rear of the HDTV.
3. Using an audio cable (white and red connectors), connect the cable to the audio output connectors associated with the DVI output on your HDTV Set-Top Box and connect the other end to the audio connectors associated with the HDMI input (white area) at the rear of the HDTV.
4. Turn on the power to the HDTV and HDTV Set-Top Box.
5. Select HDMI using the INPUT button on the remote or side of the HDTV, or directly by pressing the HDMI button on the Remote Control.

**Note:** The HDMI Input is for HD Video and will only support 640x480 at 60Hz from a PC. Use the RGB PC input for a greater selection of PC formats.

**Note:**

- a) The HDMI input on the HDTV supports High-bandwidth Digital Content Protection (HDCP). HDCP encrypts the transmission between the video source and the digital display for added security and protection.
- b) Refer to your HDTV Set-Top Box user manual for more information about the video output requirements of the product or consult your cable or satellite operator.



## 2.3.2 Using Component Video

### Connecting your HDTV Set-Top Box (Better):

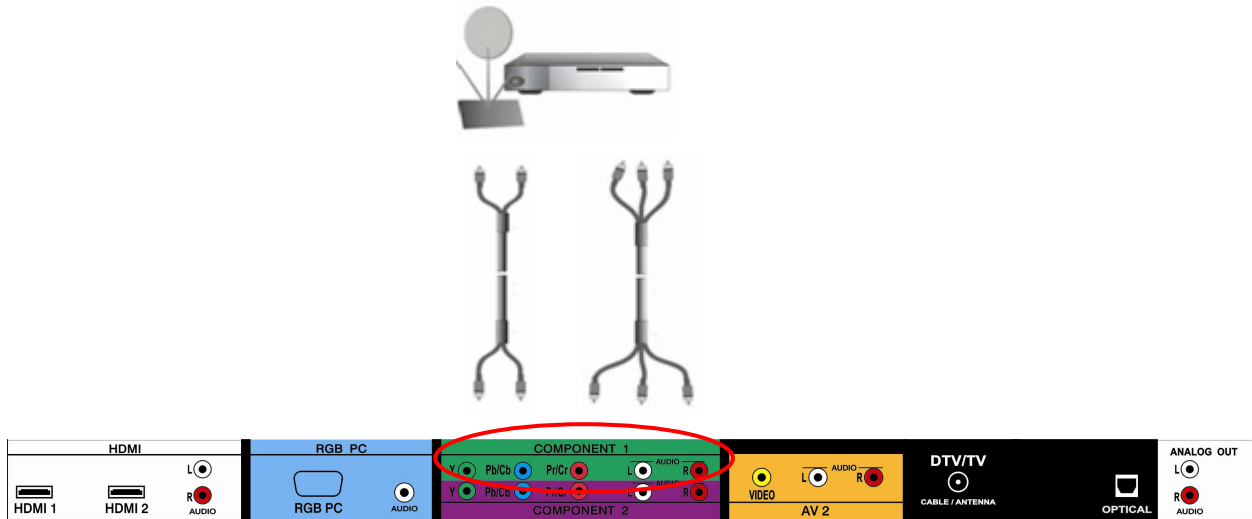

1. Turn off the power to the HDTV and HDTV Set-Top Box.
2. Connect the Y (green color) connector on your HDTV Set-Top Box to the corresponding Y (green color) connector in the Component 1 group (green color area - row of connectors nearest to you when viewing from the rear of the TV) at the rear of the HDTV.
3. Connect the Pb (blue color) connector on your HDTV Set-Top Box to the corresponding Pb (blue color) connector in the Component 1 group (green color area - row of connectors nearest to you when viewing from the rear of the TV) at the rear of the HDTV.
4. Connect the Pr (red color) connector on your HDTV Set-Top Box to the corresponding Pr (red color) connector in the Component 1 group (green color area - row of connectors nearest to you when viewing from the rear of the TV) at the rear of the HDTV.
5. Using an audio cable (white and red connectors), connect the cable to the audio output connectors associated with the Component output on your HDTV Set-Top Box and connect the other end to the audio connectors associated with the Component 1 input (green color area) at the rear of the HDTV.
6. Turn on the power to the HDTV and HDTV Set-Top Box.
7. Select Component 1 using the INPUT button on the remote or side of the HDTV, or directly by pressing the Component button on the Remote Control.

**Note:**

Refer to your HDTV Set-Top Box user manual for more information about the video output requirements of the product or consult your cable or satellite operator.



## 2.4 Connecting Your Basic Set-Top Box

### 2.4.1 Using Composite Video



1. Turn off the power to the HDTV and Set-Top Box.
2. Using the AV Cable, connect the Video (yellow color) connector on your Set-Top Box to the corresponding Video (yellow color) connector in the AV2 group (yellow color area) at the rear of the HDTV.
3. Using the white and red connectors, connect the cable to the audio output connectors associated with the Video output on your Set-Top Box and connect the other end to the audio connectors associated with the AV2 input (yellow color area) at the rear of the HDTV.
4. Turn on the power to the HDTV and Set-Top Box.
5. Select AV2 using the INPUT button on the remote or side of the HDTV, or directly by pressing the AV button on the Remote Control.



### 2.4.2 Using Coax (RF)



1. Turn off the power to the HDTV and Set-Top Box.
2. Using a Coax (RF) cable, connect one end to the TV OUT (RF) on your Set Top Box and the other end to the DTV/TV input at the rear of the HDTV.
3. Turn on the power to the HDTV and Set-Top Box.
4. Select TV using the INPUT button on the remote or side of the HDTV, or directly by pressing the TV button (below the WIDE button) on the Remote Control.

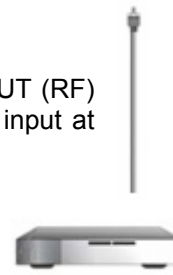

Note: Refer to your Set Top Box user manual for more information about selecting the video or RF output of the product.



## 2.5 Connecting Your VCR or Video Camera

1. Turn off the HDTV and VCR or Video Camera.
2. Connect the S-Video jack on the rear of your VCR or Video Camera to the S-Video jack in the AV1 group on the side of the HDTV.
3. Connect an audio cable (white and red connectors) cable to the audio output connectors associated with the S-Video output on your VCR or Video Camera and connect the other end to the audio connectors associated with the AV1 input on the side of the HDTV.
4. Turn on the power to the HDTV and VCR or Video Camera.
5. Select AV1 using the INPUT button on the remote or side of the HDTV, or directly by pressing the AV button on the Remote Control.

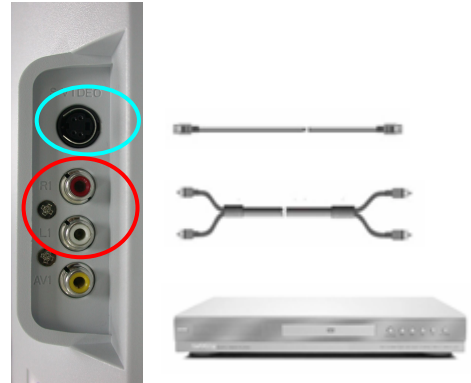

Note: Refer to your VCR or Video Camera user manual for more information about the video output requirements of the product.

## 2.6 Connecting Coaxial (RF)

### 2.6.1 Using Your Antenna or Digital Cable for DTV

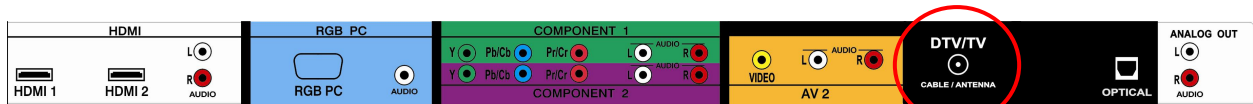

1. Turn off the power to the HDTV.
2. Connect the coaxial (RF) connector from your antenna or digital cable (out-of-the-wall, not from the Cable Box) to the DTV/TV CABLE/ANTENNA connector.
3. Turn on the power to the HDTV.
4. Select DTV using the INPUT button on the remote or side of the HDTV, or directly by pressing the TV button on the Remote Control.



Note:

- a) Not all digital TV broadcasts are High Definition (HD). Refer to the program guides, or consult your cable, satellite or TV station operator.
- b) Digital broadcasts are not available in all areas. Refer to [www.antennaweb.org](http://www.antennaweb.org) for detailed information.
- c) Make sure the antenna and coaxial cable are correctly grounded.
- d) For Professional antenna installation contact us at [www.VIZIO.com](http://www.VIZIO.com) or call 1-888-VIZIOCE (1-888-849-4623).



## 2.6.2 Using Your Antenna or Cable for TV

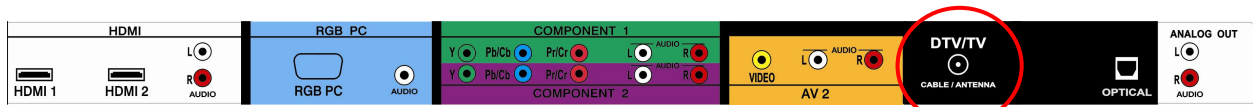

1. Turn off the power to the HDTV.
2. Connect the coaxial (RF) connector from your antenna or cable (out-of-the-wall, not from the Cable Box) to the DTV/TV CABLE/ANTENNA connector at the rear of the HDTV
3. Turn on the power to the HDTV.
4. Select TV using the INPUT button on the remote or side of the HDTV, or directly by pressing the TV button on the Remote Control.

## 2.6.3 Using the Antenna or Cable through your VCR

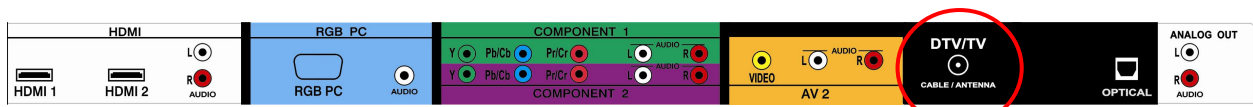

1. Turn off the power to the HDTV and VCR.
2. Connect the “Output to TV”, “RF Out” or “Antenna Out” connector on the rear of your VCR to the DTV/TV CABLE/ANTENNA connector at the rear of the HDTV.
3. Turn on the power to the HDTV and VCR.
4. Select TV using the INPUT button on the remote or side of the HDTV, or directly by pressing the TV button on the Remote Control.

Note: If you have an off-air antenna or cable TV, connect it to the “Antenna In” connector on the rear of your VCR.



## 2.7 Connecting a PC Computer



1. Turn off the power to the HDTV and PC Computer.
2. Connect a 15-pin D-Sub RGB (VGA) cable to the RGB output of your pc computer and the other end to the RGB PC input (blue area) at the rear of the HDTV.
3. Connect the Audio Out on your pc computer to the RGB PC Audio input (blue area) at the rear of the HDTV.
4. Turn on the HDTV and PC Computer.
5. Select RGB using the INPUT button on the remote or side of the HDTV, or directly by pressing the RGB button on the Remote Control.

**Note:**

- a) For the best picture quality when connecting a pc computer through RGB PC, set your pc computer timing mode to VESA 1366x768 at 60Hz. Please refer to the pc or graphic card's user guide for additional information on how to set the timing mode and the video output requirements of the product.
- b) A RGB (VGA) cable and stereo mini jack cable are not included and can be purchased at an electronics store.

### 2.7.1 Preset PC Resolutions

Resolution	Refresh (Hz)	H.Freq (kHz)	V.Freq (Hz)	H.Sync	V.Sync	Pixel Freq (MHz)
640x480	60	31.5	59.94	N	N	25.175
640x480	75	37.5	75.00	N	N	31.500
720x400	70	31.46	70.08	N	P	28.320
800x600	60	37.9	60.317	P	P	40.000
800x600	75	46.9	75	P	P	49.500
800x600	85	53.7	85.06	P	P	56.250
1024x768	60	48.4	60.01	N	N	65.000
1024x768	75	60.0	75.03	P	P	78.750
*1366x768	60	47.7	60.00	P	N	85.500

NOTES: N = Negative, P = Positive, \* = Primary (Native) Mode



## Chapter 3 Setting Up to Watch Television

For 'Preparing Your LCD HDTV for Wall Mounting', see page 5.

### 3.1 Basic LCD HDTV Start Up

1. **Connecting the Power Cable**  
Connect the power cord to the power cord connector on the back of the HDTV, and then plug the power cord into an AC wall socket.
2. **Connect Audio and Video Cables to the HDTV**  
(see pages 13 ~ 23 for detailed steps)
3. **Turning Power On**  
Once all the components are connected, press the Power ON button on the side of the HDTV, or press the Power ON (Red) button on the remote control.
4. **Select Input Source**  
Select the Input Source for the HDTV by pressing the INPUT button on the side of the TV or using the Input button on the remote control. Pressing this button will cycle you through the following options: TV, AV1, AV2, Component1, Component2, RGB, HDMI1 and HDMI2.
5. **Using DTV and TV with an Antenna or Cable**  
At first power on, the HDTV will have the DTV/TV input selected and will guide through some setup screens. If it is not the first time the HDTV has been powered on, you will need to select TV using the INPUT button on the remote control or the side of the HDTV, or directly by pressing the TV button on the remote control, and Auto Scan for the available TV channels.

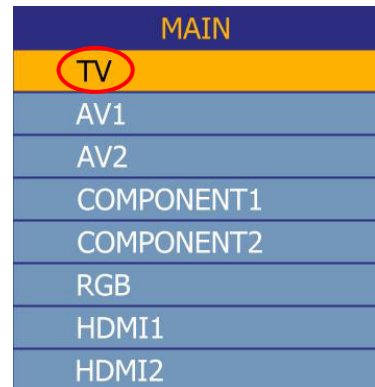

Note: If you do not see this option within the OSD, you might have selected the wrong input in the previous steps and you will need to repeat step 4 (above) to select the correct input source.

- a. The screen will show 'snow' and the first Initial Setup OSD panel.

Press the OK button on the remote control.

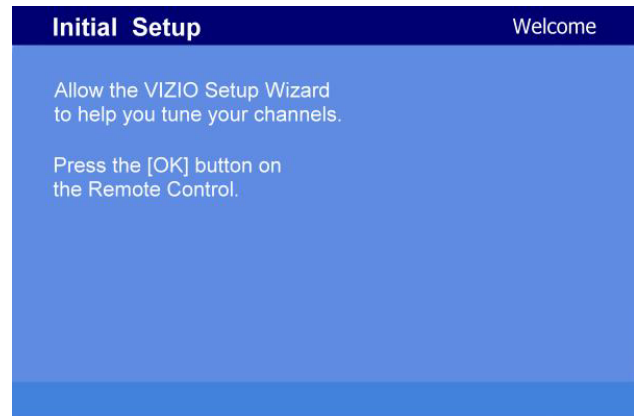





- b. The Language choice screen will be displayed; the default English option is highlighted. If you wish to change the OSD language to Français or Español, press the  button on the remote control to select the language you want.

Press the  button on the remote to go to the next screen.



- c. The Tuner screen will be displayed; default choice is Antenna. If you are using Cable, press the  button to highlight CABLE.

Press the  button on the remote to go to the next screen.

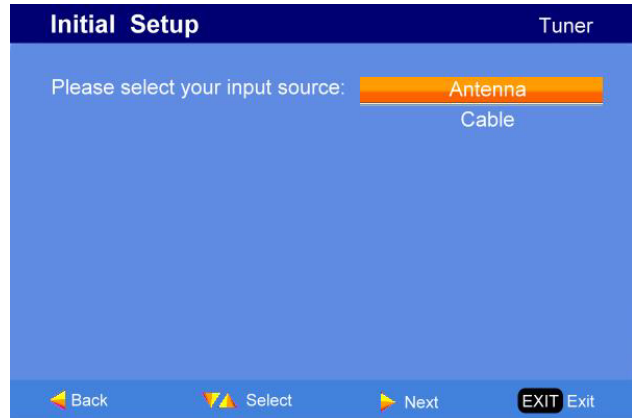

- d. The Channel Scan screen will be displayed; default choice is Scan. Press the OK button on the remote control to commence the search for available channels to be stored into memory.

If you do not want to scan for channels at this time, press the  button on the remote to highlight Skip Scan and then press the OK button.

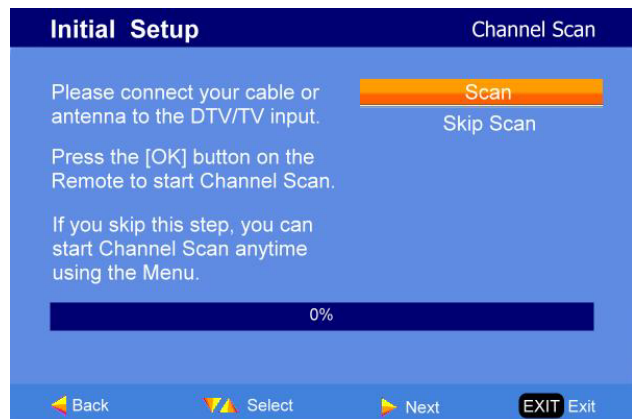

- e. The screen will now change to show the progress of the search for Analog (NTSC) and Digital (ATSC) channels.

Note: DTV digital broadcast is not available in all areas. Refer to [www.antennaweb.org](http://www.antennaweb.org) to get information about availability in your area, type of antenna and in which direction to point your antenna. The channel availability through cable depends upon which channels your cable operator supplies in Clear QAM; consult your cable operator for more information.

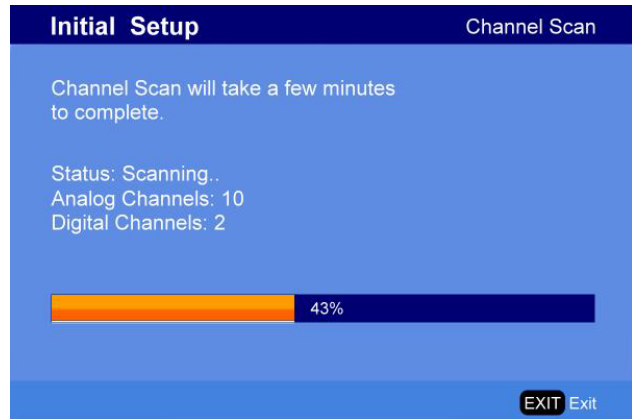

- f. When finished, the Complete screen will be displayed to inform that the HDTV has completed the Initial Setup.

Press the OK button on the remote control to exit and begin watching TV.

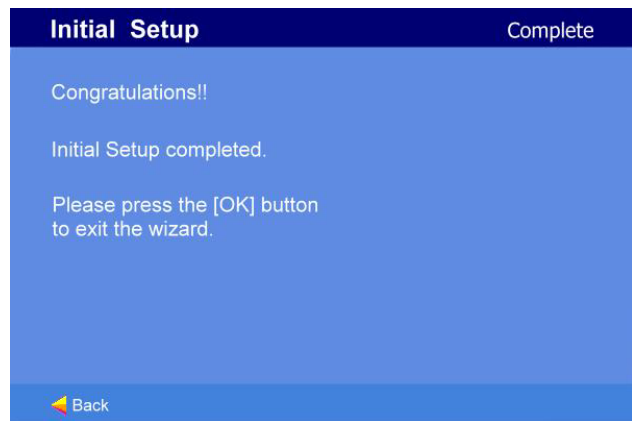

### 3.2 Using a PC

If connecting to a PC through the RGB PC input, set the TV timing mode to VESA 1366x768 at 60Hz for best picture quality (refer to the graphic card's user guide for questions on how to set this timing mode). Please see the table below for the factory preset resolutions.

Resolution	Refresh (Hz)	H.Freq (kHz)	V.Freq (Hz)	H.Sync	V.Sync	Pixel Freq (MHz)
640x480	60	31.5	59.94	N	N	25.175
640x480	75	37.5	75.00	N	N	31.500
720x400	70	31.46	70.08	N	P	28.320
800x600	60	37.9	60.317	P	P	40.000
800x600	75	46.9	75	P	P	49.500
800x600	85	53.7	85.06	P	P	56.250
1024x768	60	48.4	60.01	N	N	65.000
1024x768	75	60.0	75.03	P	P	78.750
*1366x768	60	47.7	60.00	P	N	85.500

NOTES: N = Negative, P = Positive, \* = Primary (Native) Mode



### 3.3 Watching a TV Program

Before you start watching TV, please make sure that any cable, satellite or off-air antenna connections are secure. Also, verify that the power cord is plugged into a correctly grounded electrical outlet or surge protector.

1. Press the power button on the remote or on the side of the HDTV. The VIZIO logo on the front will change from orange to white.
2. There are 3 options for selecting your programming:
  - a. If you are using an antenna or cable connected through the DTV/TV CABLE/ANTENNA input, you can select TV directly by pressing the TV button on the remote, or by pressing the INPUT button on the remote or on the side of the HDTV.
  - b. If you are watching broadcasts through a cable or satellite set-top box connected by an HDMI cable, select HDMI directly by pressing the HDMI button on the remote, or by pressing the INPUT button on the remote or on the side of the HDTV.
  - c. If you are watching broadcasts through a cable or satellite set-top box connected by a Component (YPbPr) cable, select Component directly by pressing the Component button on the remote, or by pressing the INPUT button on the remote or on the side of the HDTV.

Note: You should be able to see a picture. If you do not, make sure that all of the HDTV connections are secure and you have selected the correct video input source.

3. When using option 2a, press the Channel buttons on the remote or the +/- buttons on the side of the HDTV to change the channel. Note: The Channel buttons, on the side of the HDTV and on the remote, control will not work if you are watching a program using HDMI, Component and AV inputs.

### 3.4 Adjusting Basic HDTV Settings

#### Volume

To increase the volume, press and hold the VOL+ or VOL- button on the side of the LCD HDTV or remote control until the desired level is reached.

#### TV Channels

To step up or down through the available TV channels, press the CH+ or CH- button on the side of the HDTV or remote control once for the next or previous channel, or hold it depressed until the desired channel is reached. Note: Channel up and down will only operate in DTV and TV modes.

#### Wide

Using this feature, you can watch video content in different size modes on the HDTV. Press the WIDE button on the remote control to switch among the modes.

For more information see Section 4.17.1 – Viewing Modes, on page 46.



### 3.5 Program Information

Press the GUIDE button on the remote and program information for the channel you are watching will be displayed on the screen with the live program content in a small window in the lower left corner.

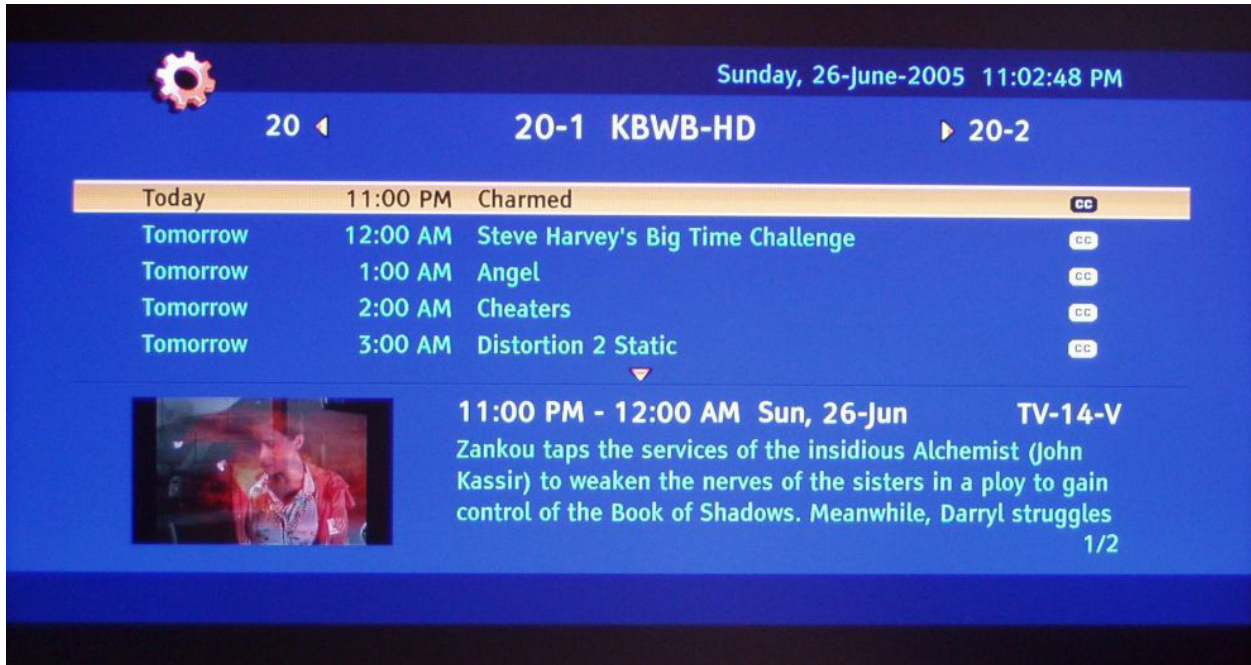

Press the or button to scroll up or down the channels. Each time you pause at a channel, the program list will update with the program schedule for the channel and the window will show the live program for that channel. Press the GUIDE button to exit this feature.

### 3.6 Information on HDTV Status

When you change TV channels or inputs, or press the INFO button on the remote, an Information Banner is displayed for a few seconds to tell you the status of the LCD HDTV.

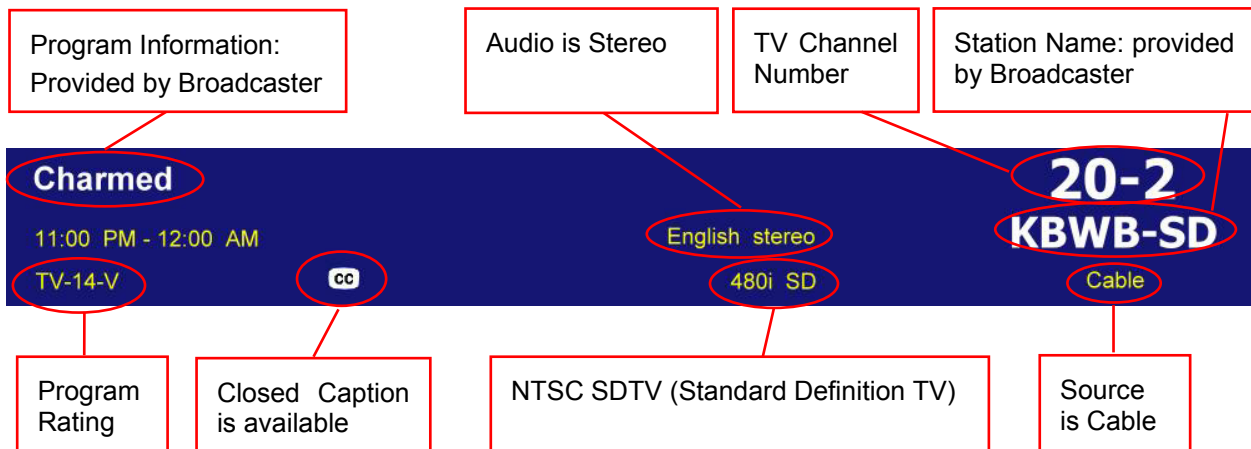



## Chapter 4 Advanced Adjustment of HDTV

### 4.1 Using the On Screen Display (OSD)

The remote control or the control buttons on the right hand side of the TV can control all the function settings. The On Screen Display (OSD) allows you to adjust the save contrast, brightness and other settings. The TV will save changes made to the settings, even if the TV is turned off.



The OSD consists of several menu options: Picture Adjust, Audio Adjust, Setup, TV Tuner Setup and Parental Controls. The main menu options may vary depending on your selected input source.

Note: Some of the main menu options may have additional submenus, i.e. the TV Rating submenu for Parental Controls.

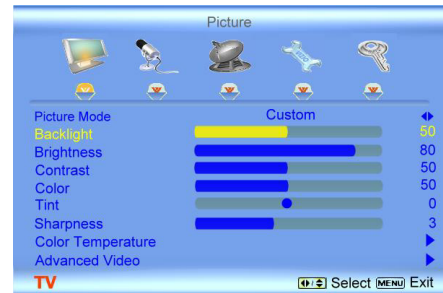
1. Press the MENU button on the remote control or the side of the TV and the Picture Adjust menu will be shown on the screen.
2. Press the  or  button on the remote control or the VOL + or VOL – button on the side of the HDTV to select one of the other menu options.



Picture Adjust      Audio Adjust      TV Tuner Setup      Setup      Parental Controls

3. Once the menu option is displayed, press the  or  button on the remote control or the CH + or CH – button on the side of the TV to select one of the items to adjust.





4. Press the  button on the remote control or the VOL – button on the side of the HDTV to begin adjustment of the item.
5. Press OK when finished.
6. Repeat steps 2 through 5 to adjust additional options within this menu.
7. Once the adjustments are completed press the MENU button repeatedly to exit the OSD completely.



## 4.2 DTV / TV Input Picture Adjustment

### 4.2.1 Picture Mode

When the MENU button is pressed, the On Screen Display (OSD) appears on the PICTURE adjustment page. Press the  button to highlight the Picture Mode selection.

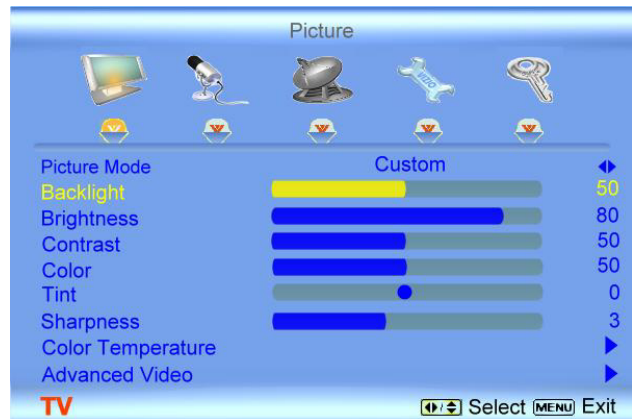
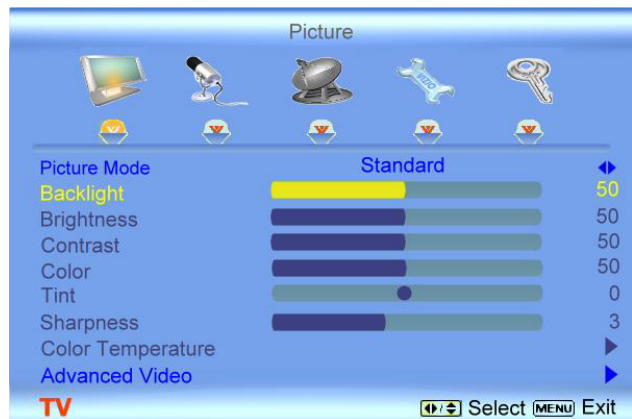
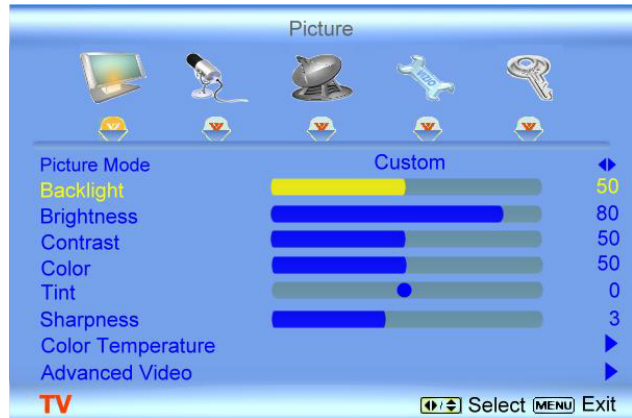

Use the  or  button to choose from Custom, Standard, Movie and Game.

If Standard, Movie or Game is chosen for the Picture Mode, then the only Picture Adjustments available for you are for the Backlight and Advanced Video; the rest are preset.



### 4.2.2 Backlight

Press the  button to highlight the Backlight selection.

Press the  button to start adjusting the brightness of the Backlight and the menu page will disappear and be replaced by a small Backlight Indicator Bar so you can see the light level between the minimum and maximum available levels. Use the  or  button to adjust the level.





The Backlight level does not affect the Brightness (black level) or Contrast (white level) of the picture, it adjusts the lamp current and this affects the overall brilliance of the picture.



### 4.2.3 Brightness

Press the  button to highlight the Brightness selection.



Press the  button to start adjusting the brightness and the menu page will disappear and be replaced by a small Brightness Indicator Bar so you can see the brightness level between the minimum and maximum available levels. Use the  or  button to adjust the level.



The Brightness adjusts the black levels in the picture. If the brightness is too low you will not be able to see the detail in darker parts of the picture and if the brightness is too high the picture will look washed out.

### 4.2.4 Contrast

Press the  button to highlight the Contrast selection.



Press the  button to start adjusting the contrast and the menu page will disappear and be replaced by a small Contrast Indicator Bar so you can see the contrast level between the minimum and maximum available levels. Use the  or  button to adjust the level.



The Contrast adjusts the white levels in the picture. If the contrast is too low the picture will look washed out and if the contrast is too high you will not be able to see any detail in the bright parts of a picture.

### 4.2.5 Color

Press the  button to highlight the Color selection.

Press the  button to start adjusting the color and the menu page will disappear and be replaced by a small Color Indicator Bar so you can see the color level between the minimum and maximum available levels. Use the  or  button to adjust the level.



The Color adjusts the amount of color in the picture.

### 4.2.6 Tint

Press the  button to highlight the Tint selection.

Press the  button to start adjusting the tint and the menu page will disappear and be replaced by a small Tint Indicator Bar so you can see the tint adjustment to the left or right of the nominal position.

Use the  or  button to adjust the level.





The Tint adjusts the hue of the picture. The easiest way to set tint is to look at flesh tones and adjust for a realistic appearance. In most cases, the default middle position is correct. If people's faces look too orange try reducing the level of color first as the case of this is often too much color



### 4.2.7 Sharpness

Press the  button to highlight the Sharpness selection.

Press the  button to start adjusting the sharpness and the menu page will disappear and be replaced by a small Sharpness Indicator Bar so you can see the sharpness level between the minimum and maximum available levels. Use the  or  button to adjust the level.





The Sharpness adjusts the sharpness of the picture.

### 4.2.8 Color Temperature



Press the  button to highlight the option for Color Temperature selection.

The default is NORMAL; this is the 6500K setting.

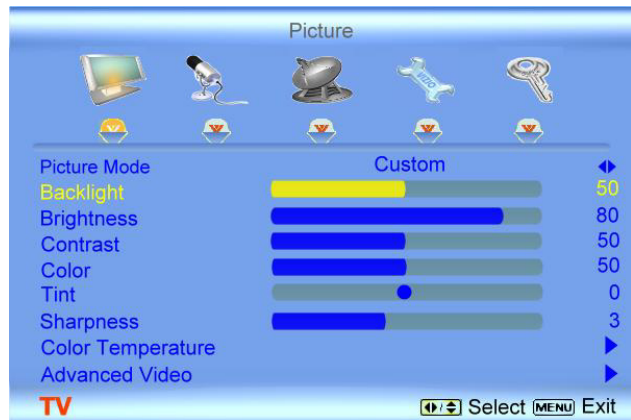
Press the  or  button if you want to choose the Cool or Warm option.



If you choose the Custom option, then a new menu will be displayed showing the primary color items, Red, Green and Blue. Press the  button to highlight the color you wish to adjust.

Press the  button to start adjusting the color and the menu page will disappear and be replaced by a small Color (Red, Green or Blue) Indicator Bar as before. Use the  or  button to adjust the color.

Press the OK button when finished. Repeat the procedure to adjust the other colors if desired.

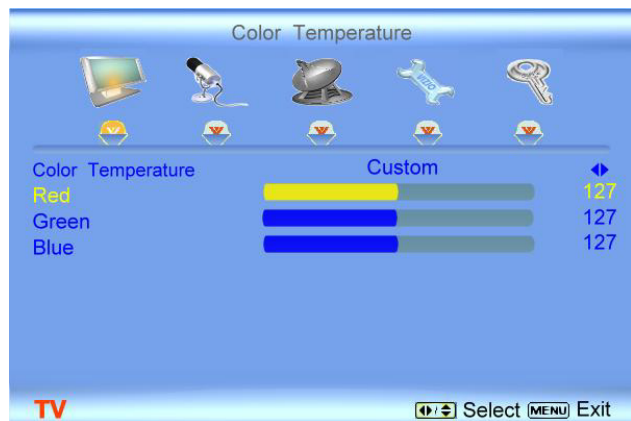





### 4.2.g Advanced Video



Press the  button to highlight the option for Advanced Video selection and press the OK button. A new menu will be displayed showing the advanced functions available for fine tuning of the picture.





#### DNR

Press the  button to highlight DNR (Dynamic Noise Reduction). Use this feature to diminish picture artifacts caused by the digitizing of image motion content that may be present in the picture. Press the  or  button to choose from the Off, Low, Medium or Strong setting.



#### Black Level Extender

Press the  button to highlight Black Level Extender. Use this feature to increase the picture reproduction performance in the dark areas of the picture. Press the  or  button to turn this feature On or Off.



#### White Peak Limiter

Press the  button to highlight White Peak Limiter. Use this feature to limit excessive white in bright areas of the picture, caused by a lower sync level for a channel being received from the antenna or cable. Press the  or  button to turn this feature On or Off.



#### CTI

Press the  button to highlight CTI (Color Transient Improvement). This feature can be used to reduce the time taken to transition from one color to another. The effect will be seen as sharpening the border between colors. Press the  or  button to choose from the Off, Low, Medium or Strong setting.

#### Flesh Tone

Press the  button to highlight Flesh Tone. In some cases, activation of this feature can result in a more pleasing production of sky and flesh color. Press the  or  button to turn this feature On or Off.

#### Adaptive Luma

Press the  button to highlight Adaptive Luma. Large areas of darkness in a picture will result in a lower Average Picture Level (APL) and the overall picture will look too dark; activation of this feature will raise the APL to counteract this effect. Press the  or  button to turn this feature On or Off.





## 4.3 DTV / TV Input Audio Adjustment

### 4.3.1 Volume

When the MENU button is pressed, the On Screen Display (OSD) appears on the PICTURE adjustment page. Press the  button to display the AUDIO ADJUST page.



Press the  button to highlight the Volume selection.



Press the  button to start adjusting the volume and the menu page will disappear and be replaced by a small Volume Indicator Bar so you can see the volume level between the zero and maximum available levels. Use the  or  button to adjust the level.



The Volume Indicator Bar will also appear when watching a program on your TV is the Volume button on the remote or the side of the TV is pressed.



### 4.3.2 Bass

Press the  button to highlight the Bass selection.

Press the  button to start adjusting the bass and the menu page will disappear and be replaced by a small Bass Indicator Bar, as before, so you can see the bass level between the zero and maximum available levels. Use the  or  button to adjust for bass boost or attenuation.



### 4.3.3 Treble

Press the  button to highlight the Treble selection.

Press the  button to start adjusting the treble and the menu page will disappear and be replaced by a small Treble Indicator Bar, as before, so you can see the treble level between the zero and maximum available levels. Use the  or  button to adjust for treble boost or attenuation.

### 4.3.4 Balance

Press the  button to highlight the Balance selection.

Press the  button to start adjusting the balance and the menu page will disappear and be replaced by a small Balance Indicator Bar, as before, so you can see the balance adjustment to the left or right of the nominal position. Use the  or  button to adjust the left/right balance.



### 4.3.5 Surround

Press the  button to highlight the Surround selection.

Press the  button to select for the simulated surround sound feature to be On or Off.

### 4.3.6 Speakers

Press the  button to highlight the Speakers selection.

Press the  button to turn the internal speakers On or Off. You may want to turn-off the internal speakers when listening to the audio through your Home Theatre System.

## 4.4 DTV / TV Tuner Setup

When you first used your VX37L you will have setup your TV for DTV / TV channels using the Initial Setup screens. If you did not do this or if your setup has changed, you can do this from the TV TUNER SETUP menu.

### 4.4.1 Tuner Mode

When the MENU button is pressed, the On Screen Display (OSD) appears on the PICTURE adjustment page. Press the  button to display the TV page.

Press the  button to highlight the Tuner Mode selection.

Press the  button to choose Cable or Air (Antenna) depending upon which equipment you have attached to the DTV / TV Input.





### 4.4.2 Auto Search

Press the  button to highlight the Auto Search selection.

Press the  button to Auto Search for TV channels available. The TV will automatically search for analog and digital channels.



### 4.4.3 Skip Channel

After the TV has stored all of the available DTV channels in memory you will find that some channels will be too weak to watch comfortably or they may be channels you do not want to see. Select the channel you wish to remove, press the MENU and  buttons to open the TV TUNER SETUP menu and then press the  button to highlight SKIP CHANNEL. Press the  button to select this channel to be skipped when using the CH+ or CH- button. You will still be able to select this channel using the number buttons on the remote control.



### 4.4.4 Time Zone

Setting the correct Time Zone for your area will ensure that the correct program times are shown after pressing the GUIDE button on the remote control.

Press the  button to highlight the Auto Search selection.

Press the  button to select your area.

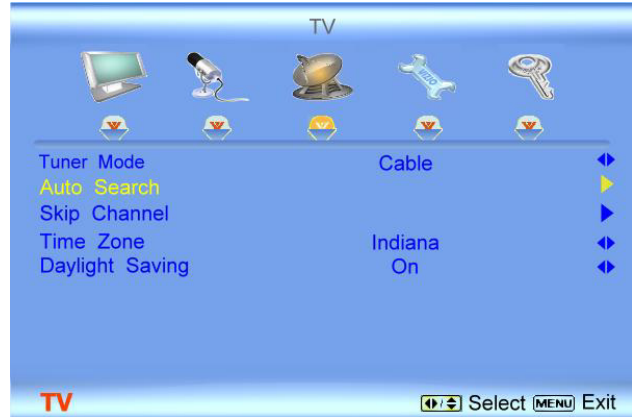



### 4.4.5 Daylight Saving

As for Time Zone, setting the daylight saving time for your area will ensure that the correct program times are shown after pressing the GUIDE button on the remote control. Press the  button to highlight the Daylight Saving selection. Press the  button to select On or Off.

## 4.5 DTV / TV Input Setup

### 4.5.1 Language



When the MENU button is pressed, the On Screen Display (OSD) appears on the PICTURE adjustment page. Press the  button until the SETUP page is displayed.

Press the  button to highlight the Language selection. The default is English.

Press the  button to select Français or Español.



### 4.5.2 Sleep Timer

Press the  button to highlight the Sleep Timer selection. Press the  button to select the timer to turn-off the TV in 30, 60, 90 or 120 minutes.

### 4.5.3 Analog Closed Caption

When watching regular analog (NTSC) TV, the Analog CC feature is available in the Setup menu.

Press the  button to highlight the Analog CC selection.

Press the  button to select CC1, CC2, CC3 or CC4. **Closed Caption for regular TV is usually CC1 or CC2.**

### 4.5.4 Digital Closed Caption

When watching DTV, the Digital CC feature is available in the Setup menu.

Press the  button to highlight the Digital CC selection.

Press the  button to select Service 1.



### 4.5.5 Digital Closed Caption Style

When selecting Digital Closed Caption you are also able to customize the look of the Closed Caption.

Press the  button to highlight the Digital CC Style selection. The default is Broadcast which means the style is the same as the broadcast channel has chosen for transmission.

Press the  button to select Custom.

The Custom page allows you to change the font size and color, the background color, and the transparency of the Closed Caption.



### 4.5.6 Reset All Settings

Press the  button to highlight the Reset All Settings selection.

Press the  button to reset the TV to the default factory settings.

**Note: This does NOT reset the Parental Control Password.**



## 4.6 DTV / TV Input Parental Control

### 4.6.1 Channel Block

If you want to restrict certain channel and program viewing, you can do this by turning on the Parental Control. Selected programs, movies and channels can then be made available only after an authorized password has been entered and accepted by the TV.

When the MENU button is pressed, the On Screen Display (OSD) appears on the PICTURE adjustment page. Press the  button to display the PARENTAL page.

The Password must be entered before the TV will continue with Parental settings. The default password set in the factory is 0 0 0 0. If you are going to use the Parental Control feature you should change the password.

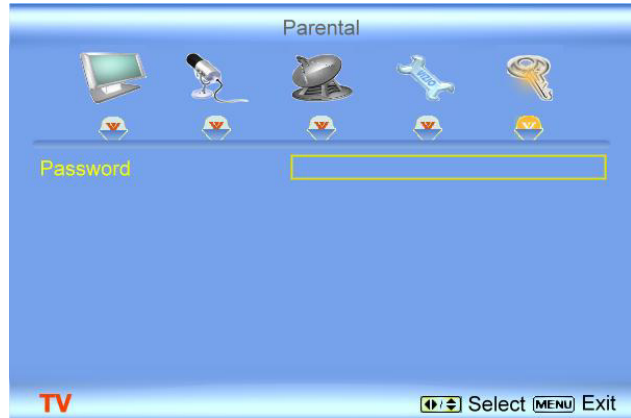

Note: Make sure you write down and store the new password in a secure place. The Reset All Settings feature (see page 37) does NOT reset the password.

Press the  button to highlight the Channel Block selection.

Press the  button to turn it on or off.



### 4.6.2 TV Rating

Follow the procedure in the previous section 4.6.1 to display the Parental Control menu and then press the button to highlight the TV Rating selection.

Press the button and the Block TV Rating panel will be displayed.

In the Block TV Rating panel you can customize the program blocking of the following TV ratings:

- Y – All children
- Y7 – Older children
- G – General audience
- PG – Guidance suggested
- 14 – Strongly cautioned
- MA – Mature audience

You can also customize the TV ratings for the following content:

- A – Sexual dialog
- D – Sexual dialog
- L – Adult language
- S – Sexual situations
- V - Violence
- FV – Fantasy violence

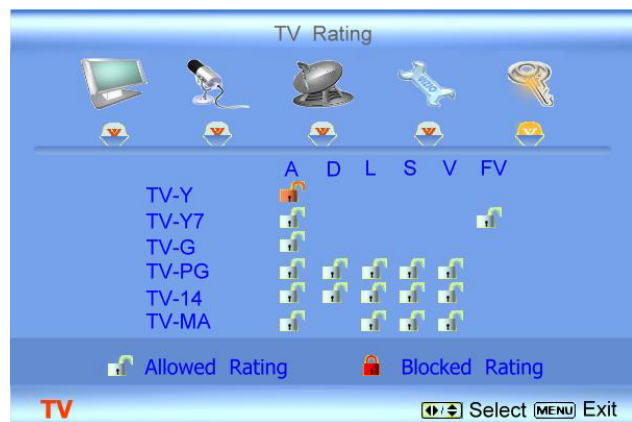

Press the or button to navigate through the TV rating options. Press the button to block (locked) or allow (unlocked).

### 4.6.3 Movie Rating

Press the button to highlight the Movie Rating selection.

Press the button and the Block Movie Rating panel will be displayed.

In the Block Movie Rating panel you can customize the program blocking of the following Movie ratings:

- G – General audience
- PG – Parental guidance suggested
- PG-13 – Recommended for children 13 years of age or older
- R – Mature audience
- NC-17 – No one under 17 years of age
- X – No one under 17 years of age



Press the or button to navigate through the Movie rating options. Press the button to block (locked) or allow (unlocked).



### 4.6.4 Blocked Unrated Programming

Follow the procedure in the previous section 4.6.1 to display the Parental Control menu and then press the  button to highlight the Block Unrated TV selection.

Press the  button to turn-on or turn-off the blocking of programming that does not have a rating.



### 4.6.5 Change the Password

Press the  button to highlight the Access Code Edit selection.

Press the  button and the new Password panel will be displayed.

Enter the new, 4-digit password using the number buttons on the remote. Enter it a second time to confirm you entered it correctly.



Note: Make sure you write down and store the new password in a secure place. The Reset All Settings feature (see page 37) does NOT reset the password.





## 4.7 HDMI Input Picture Adjustment

The Picture Adjust menu operates in the same way for the HDMI Input as for the DTV / TV input in section 4.2. The menu difference is that there is no icon along the top for DTV / TV or Parental Control adjustments.

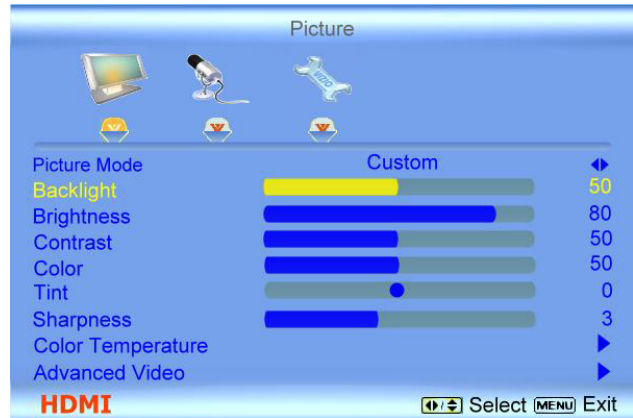

## 4.8 HDMI Input Audio Adjustment

The Audio Adjust menu operates in the same way for the HDMI Input as for the DTV / TV input in section 4.3. The menu difference is that there is no icon along the top for DTV / TV or Parental Control adjustments.

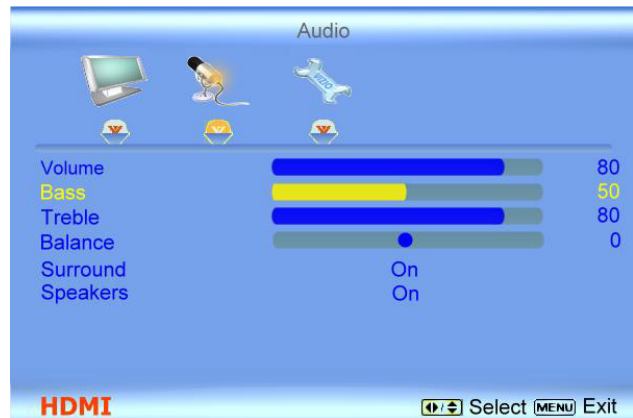

## 4.9 HDMI Input Setup

The Setup menu operates in the same way for the HDMI Input as for the TV input in section 4.4. The menu difference is that there is no icon along the top for DTV / TV or Parental Control adjustments.



### 4.10 Video Input Picture Adjustment

The Picture Adjust menu operates in the same way for Video Inputs (Component and AV) as for the DTV / TV input in section 4.2. The menu difference is that there is no icon along the top for DTV / TV adjustments.

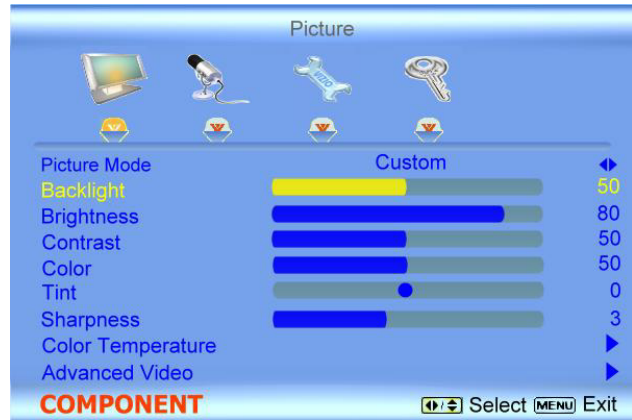

### 4.11 Video Input Audio Adjustment

The Audio Adjust menu operates in the same way for Video Inputs (Component and AV) as for the DTV / TV input in section 4.3. The menu difference is that there is no icon along the top for DTV / TV adjustments.

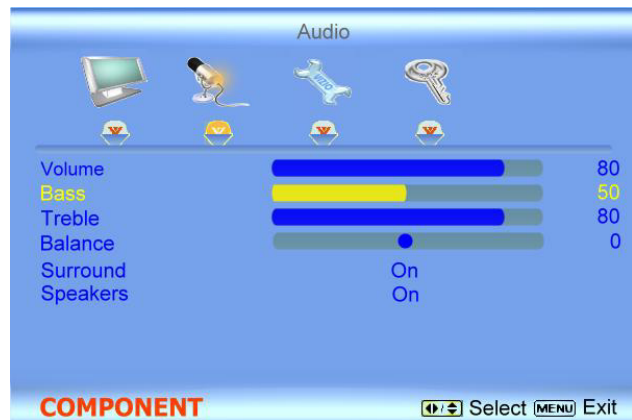

### 4.12 Video Input Setup

The Setup menu operates in the same way for Video Inputs (Component and AV) as for the TV input in section 4.4. The menu difference is that there is no icon along the top for TV adjustments.

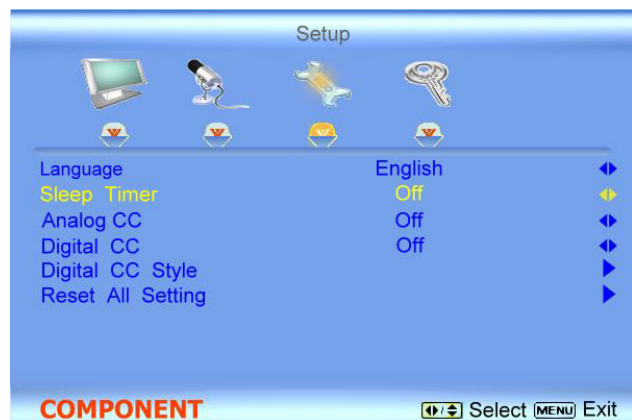

### 4.13 Video Input Parental Control

The Parental Control menu operates in the same way for Video Inputs (Component and AV) as for the DTV / TV input in section 4.6. The menu difference is that there is no icon along the top for DTV / TV adjustments.



### 4.14 PC Input Picture Adjustment

The Picture Adjust menu operates in the same way for the PC Input as for the DTV / TV input in section 4.2 for Backlight, Contrast, Brightness and Color Temperature.

#### 4.14.1 Auto Adjust

When the MENU button is pressed, the On Screen Display (OSD) appears on the PICTURE adjustment page. Press the button to highlight the Auto Adjust selection.

Press the button for the LCD HDTV to adjust to the PC signal timing automatically.

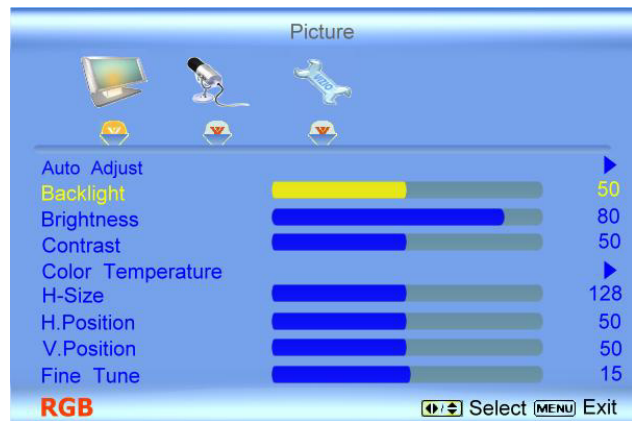

#### 4.14.2 Backlight

Press the button to highlight the Backlight selection.

Press the button to start adjusting the brightness of the Backlight and the menu page will disappear and be replaced by a small Backlight Indicator Bar so you can see the light level between the minimum and maximum available levels. Use the or button to adjust the level.



The Backlight level does not affect the Brightness (black level) or Contrast (white level) of the picture, it adjusts the lamp current and this affects the overall brilliance of the picture.

#### 4.14.3 Brightness

Press the button to highlight the Brightness selection.

Press the button to start adjusting the brightness and the menu page will disappear and be replaced by a small Brightness Indicator Bar so you can see the brightness level between the minimum and maximum available levels. Use the or button to adjust the level.





The Brightness adjusts the black levels in the picture. If the brightness is too low you will not be able to see the detail in darker parts of the picture and if the brightness is too high the picture will look washed out.

#### 4.14.4 Contrast

Press the button to highlight the Contrast selection.

Press the button to start adjusting the contrast and the menu page will disappear and be replaced by a small Contrast Indicator Bar so you can see the contrast level between the minimum and maximum available levels. Use the or button to adjust the level.



The Contrast adjusts the white levels in the picture. If the contrast is too low the picture will look washed out and if the contrast is too high you will not be able to see any detail in the bright parts of a picture.

#### 4.14.5 Color Temperature

Press the button to highlight the option for Color Temperature selection.

The default is NORMAL; this is the 6500K setting.

Press the or button if you want to choose the Cool or Warm option.

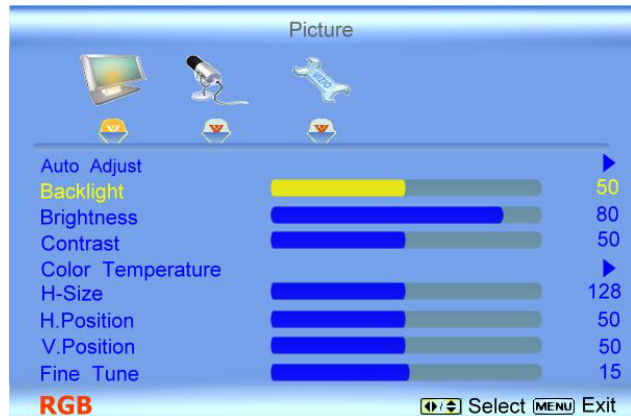

If you choose the Custom option, then a new menu will be displayed showing the primary color items, Red, Green and Blue. Press the button to highlight the color you wish to adjust.



Press the button to start adjusting the color and the menu page will disappear and be replaced by a small Color (Red, Green or Blue) Indicator Bar as before. Use the or button to adjust the color.

Press the OK button when finished. Repeat the procedure to adjust the other colors if desired.







### 4.14.6 H-SIZE

Press the  button to highlight the H-Size selection.

Press the  button to start adjusting the horizontal size of the picture. Use the  or  button to adjust the horizontal size.



### 4.14.7 H. Position

Press the  button to highlight the Horizontal Shift selection.

Press the  button to start adjusting the horizontal position of the picture. Use the  or  button to adjust the horizontal position.

### 4.14.8 V. Position

Press the  button to highlight the Vertical Shift selection.

Press the  button to start adjusting the vertical position of the picture. Use the  or  button to adjust the vertical position.

### 4.14.9 Fine Tune

Press the  button to highlight the Fine Tune selection.

Press the  button to start tuning the to the PC signal. Use the  or  button to adjust the tuning.

## 4.15 PC Input Audio Adjustment

The Audio Adjust menu operates in the same way for the PC Input as for the DTV / TV input in section 4.3. The menu difference is that there are no icons along the top for DTV / TV and Parental Control adjustments.

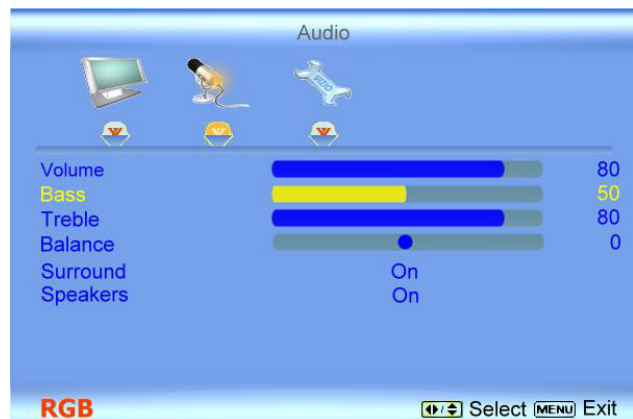

## 4.16 PC Input Setup

The Setup menu operates in the same way for the PC Input as for the DTV / TV input in section 4.4. The menu difference is that there is no icon along the top for TV adjustments and no Closed Caption.



## 4.17 Understanding Viewing Features

Your HDTV features four viewing modes and Picture-In-Picture (PIP) mode. You can switch viewing modes using the remote control.

### 4.17.1 Viewing Modes

#### Normal Mode

The original 4:3 aspect ratio (1.33:1 source) is preserved, so black bars are added to the left and right of the display image. Standard TV broadcasts are displayed with a 4:3 Aspect Ratio. Movies in 4:3 Aspect Ratio may be referred to as pan-and-scan or full frame. These movies were originally filmed in 16:9 (widescreen), and then modified to fit a traditional TV screen (4:3).

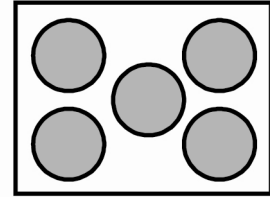

#### Wide Mode

When watching a standard broadcast or full-frame movie in this mode, the display image is stretched proportionately to fill the TV screen. When watching a widescreen (1.78:1 source) program or movie, the display image fills the TV screen. If you are watching a widescreen (1.85:1 or 2.35:1 source) program or movie, there will still be black bars at the top and bottom.

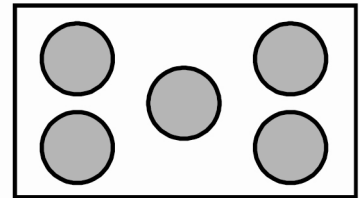

#### Zoom Mode

When watching a widescreen (1.78:1, 1.85:1, or 2.35:1 source) program or movie, the display image is zoomed proportionally to fill the width of the screen. The top and bottom are cut off to remove most of the source material's black bars. This mode is good for programs or movies with sub-titles.

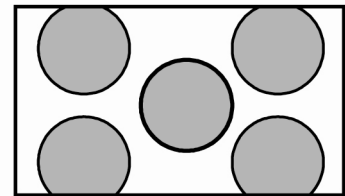

#### Panoramic Mode

When watching a standard broadcast or full frame movie in this mode, the 4:3 Aspect Ratio (1.33:1 source) display image is stretched horizontally on the left and right sides to fill the TV screen. The center of the image is not stretched.

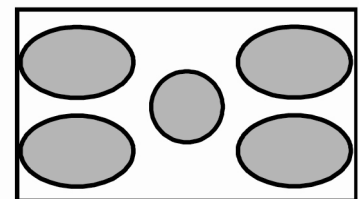

Note: Viewing modes are saved based on input. For example, you last watched a DVD in widescreen mode and then watched TV in standard mode. When you switch back to DVD input, the viewing mode will return to widescreen.



### 4.17.2 Picture-In-Picture(PIP) Mode

Your TV features PIP mode so you can watch two pictures at the same time. When PIP is turned on, you can display two pictures at one time. One picture is displayed as the full screen (main screen) and the other picture is displayed in a small window (sub screen). The sub-screen can be set to small, medium or large.

See below for detailed information regarding the PIP sources.

MAIN \ SUB	SUB					
	DTV / TV	AV	Component	RGB	HDMI	
DTV / TV			✓	✓	✓	
AV			✓	✓	✓	
Component	✓	✓			✓	
RGB	✓	✓			✓	
HDMI	✓	✓	✓	✓		

“✓” – Indicates which inputs are available for PIP mode.

\*When HDMI is used for the Sub-Screen it cannot support 1080i.

### 4.17.3 Adjusting Basic PIP Settings

The PIP channel is independent of the main TV channel. To change the PIP channel, press the PIP CH + or - button on the remote control.

Repeated pressing of the PIP button will turn on, turn off the PIP mode.

PIP
TV
AV1
AV2
COMPONENT1
COMPONENT2
RGB
HDMI1
HDMI2

Repeated pressing of the PIP INPUT button will cycle through the inputs for PIP. This button has no effect when PIP is off.



Press the PIP SIZE button to alternate between Small, Medium and Large PIP sizes.

You can swap the program that is in the main picture with the program in the PIP sub-picture. To swap the main picture program with the PIP sub-picture program, press SWAP on the remote control. If you press SWAP again, it will return the program to the main picture.



### 4.17.4 Setting the Sleep Timer

The Sleep Timer lets you set a time delay to turn off the LCD HDTV automatically.

To set the Sleep Timer using the remote control:

1. Press the SLEEP button on the remote control. The Sleep Timer appears in the center of your screen.
2. Press the SLEEP button one or more times to select the time you want. The choices are 30, 60, 90 or 120 minutes.

To turn off the sleep time using the remote control, press the SLEEP button repeatedly until Off appears on the screen.

### 4.18 Using a Cable or Satellite Remote

Your VIZIO remote uses codes 11758 and 10178 to work your LCD HDTV. To use a cable or satellite remote to work the LCD HDTV, refer to your cable or satellite remote user guide for more information on how to program the remote. If your cable or satellite remote uses a 5-digit code (like most Direct TV units), first try 11758 and then, if that does not work, 10178. If your cable or satellite remote uses a 4-digit code, try 1758 and then 0178 as an alternative. If your cable or satellite remote uses a 3-digit code (EchoStar or Dish Network for example), use code 627.

**Note:** Some buttons may not function as expected on your cable or satellite remote. Typically power, volume and mute will work.





## Chapter 5 Maintenance and Troubleshooting

### 5.1 Maintenance

#### Important

1. Make sure that the power cable is removed from the socket before cleaning the TV.
2. Do not use volatile solvent (such as toluene, rosin and alcohol) to clean the TV. Such chemicals may damage the housing, screen glass and remote control, and cause paint to peel.

#### Cleaning the Housing and Remote Control

1. Use the VIZIO soft cloth (included) for cleaning.
2. If the housing or remote control is seriously contaminated, use a soft cloth moistened with diluted neutral cleaner to clean the display. Wring water out of the cloth before cleaning to prevent water from penetrating into the housing. Wipe the display with a dry cloth after cleaning.

#### Cleaning the Screen

1. Use the VIZIO soft cotton cloth (included) to gently clean the screen.
2. The screen glass is very fragile. Do not scrape it with any sharp object. Do not press or tap the screen to avoid cracking. When the screen is seriously contaminated, use a soft cloth moistened with diluted neutral cleaner to clean the display. Wring water out of the cloth before cleaning to prevent water from penetrating into the housing. Wipe the display with a dry cloth after cleaning.

### 5.2 Troubleshooting Guide

If the TV fails or the performance changes dramatically, check the display in accordance with the following instructions. Remember to check the peripherals to pinpoint the source of the failure. If the display still fails to perform as expected, contact the VIZIO for assistance by calling 1-714-668-0588 or e-mail us at [techsupport@vinc.com](mailto:techsupport@vinc.com).

Problem	Solution
No power.	<p>Make sure the power button is ON (White VIZIO Logo).</p> <p>Make sure AC power cord is securely connected to the AC socket.</p> <p>Plug another electrical device (like a radio) to the power outlet to verify that the outlet is supplying the proper voltage.</p>
No sound.	<p>Check your audio connection</p> <p>Press MUTE on the remote control, so that mute symbol disappears from the screen</p> <p>Check your audio settings, your TV audio may be set to SAP, min or speakers off</p> <p>Press the Volume + (Up) key on your remote control</p> <p>Make sure that headphones are not connected</p>
If the screen is black.	<p>Check your input connections.</p>



Problem	Solution
Power is ON but no screen image.	<p>Make sure the video cable supplied with the TV is secured to the correct video output port on the back of the VCR and the TV. Make any cable you have attached to the TV is secured to the correct output your Set-Top Box, DVD, etc.</p> <p>Adjust brightness and contrast.</p> <p>Check Source settings.</p>
Wrong or abnormal colors appear.	<p>If any colors (red, green, or blue) are missing, check the video cable to make sure it is securely connected.</p>
Control buttons do not work.	<p>Press only one button at a time.</p>
Remote Control does not work.	<p>Make sure batteries are inserted correctly</p> <p>Batteries could be weak.</p>
There appears to be image quality issues.	<p>For best image quality, view HD wide screen programs where possible. If HD content is not available view "Standard Definition" from a digital source. Standard, analog TV will always be noticeably inferior to HD because your digital flat panel TV has video that is many times better than old TV's and so you can see interference and deficiencies you did not know you had.</p>
You cannot see a picture.	<p>Make sure that the power cord is plugged into a grounded electrical outlet.</p> <p>Make sure that the power button is turned on.</p> <p>Make sure that the selected input source is connected to a working input source.</p> <p>If your TV is connected to your computer in RGB or HDMI mode, press any key on your keyboard to "wake" your computer.</p>
You see a distorted picture or hear unusual sound.	<p>You may be getting interference from electrical appliances, cars, motorcycles, or fluorescent lights. If you have not mounted it on the wall, try moving your TV to another location to see if this is the cause of the problem.</p>
The picture has abnormal patterns.	<p>Make sure that the input source cable is attached securely and correctly to the back of your TV.</p> <p>Make sure that the video input source is within the range of your TV. Compare the video input source's specifications with your TV specifications.</p>
The display image does not cover the entire screen.	<p>If you are using RGB mode, make sure that H Size and V Position in the On Screen Display (OSD) are set correctly.</p> <p>If you are using TV, AV-C, AV-S or Component with 480i input, use the WIDE button on the remote control to scroll through various screen modes.</p>
You can see a picture but you cannot hear sound.	<p>Make sure that the volume is not turned down.</p> <p>Make sure that the sound is not muted.</p> <p>Make sure that your audio input source cables are connected securely and correctly.</p>
The TV has pixels that are always dark or colored.	<p>Your LCD HDTV is manufactured using an extremely high level of precision technology, however, sometimes some pixels of your LCD HDTV may not display. Pixel defects within industry specifications are inherent to this type of product and do not constitute a defective product.</p>
You see "noise" or "trash" on the screen.	<p>When your LCD HDTV's digital capabilities exceed a digital broadcast signal, the signal is up-converted (increased) to match your TV's display capabilities. Up-converting can cause noise or trash.</p>
You switch to a different input and the volume changes.	<p>The TV remembers the volume level from the last time you adjusted it. If the sound level is higher or lower from another source, then the loudness will change.</p>
You switch to a different input and the screen size changes.	<p>The TV remembers the viewing mode from the last time you used a particular input (AV, Component, HDMI and TV).</p>



<p>Tips for High-Definition Users.</p>	<p>The LCD HDTV is an ideal platform for viewing High Definition Content. Best Image Quality will be achieved by the HDMI Input, then YPbPr, then RGB. However, due to variances in broadcast practices, it is possible some image distortions can occur.</p>
<p>Tips for Letterbox Content Users.</p>	<p>Letterboxed (or “Widescreen”) versions of DVD movies are most commonly formatted for standard 4:3 Televisions. The LCD HDTV has the capability of expanding this content so the entire screen is filled at the expense of image accuracy. To use this function, press the “ZOOM” key on the remote control and cycle among the available options.</p>

### 5.3 Telephone & Technical Support

Products are often returned due to a technical problem rather than a defective product that may result in unnecessary shipping charges billed to you. Our trained support personnel can often resolve the problem over the phone. For more information on warranty service or repair, after the warranty period, please contact our Support Department at the number below.

Customer support and quality service are integral parts of VIZIO’s commitment to service excellence. For technical assistance contact our VIZIO Technical Support Department via email or phone.

E-mail: [techsupport@vinc.com](mailto:techsupport@vinc.com)

Tel: (714)668-0588

Hours of operations:

6:00am – 6:00pm PST Monday – Friday

10:00am – 2:00pm PST Saturday – Sunday

Please have your VIZIO model number, serial number and date of purchase available before you call.

**VIZIO**

320A Kalmus Drive

Costa Mesa, CA 92626

Tel: (714) 668.0588 Fax: (714) 668-9099

Web: [www.VIZIO.com](http://www.VIZIO.com)



## 5.4 Compliance

Caution: Always use a power cable that is properly grounded. Please use the AC cords listed below for each area.

USA	UL
Canada	CSA
Germany	VDE
UK	BASE/BS
Japan	Electric Appliance Control Act

## 5.5 FCC Class B Radio Interference Statement

NOTE: This equipment has been tested and found to comply with the limits for a Class B digital device, pursuant to Part 15 of the FCC Rules. These limits are designed to provide reasonable protection against harmful interference in a residential installation. This equipment generates, uses and can radiate radio frequency energy, and if not installed and used in accordance with the instructions, may cause harmful interference to radio communications. However, there is no guarantee that interference will not occur in a particular installation. If this equipment does cause harmful interference to radio or television reception, which can be determined by turning the equipment off and on, the user is encouraged to try to correct the interference by one or more of the following measures:

1. Reorient or relocate the receiving antenna.
2. Increase the separation between the equipment and receiver.
3. Connect the equipment into an outlet on a circuit different from that to which the receiver is connected.
4. Consult the dealer or an experienced radio/TV technician for help.

Notice:

1. The changes or modifications not expressly approved by the party responsible for compliance could void the user's authority to operate the equipment.
2. Shielded interface cables and AC power cord, if any, must be used in order to comply with the emission limits.
3. The manufacturer is not responsible for any radio or TV interference caused by unauthorized modification to this equipment. It is the responsibilities of the user to correct such interference.



## Chapter 6 Miscellaneous Information

### 6.1 Specifications

Specifications	
Panel	37" Diagonal, 16:9 Aspect Ratio
Resolution	1366 x 768 pixels
Pixel (Dot) Pitch	0.6mm (H) x 0.6mm (V)
Display Compatibility	HDTV (720P)
Signal Compatibility	480i (SDTV), 480P (EDTV), 720P (HDTV), 1080i (HDTV)
Colors	16.77 Million (8-bit)
Brightness	500 cd/m <sup>2</sup> (typical)
Contrast	1000:1 (typical)
Response Time	6mS (typical)
Viewing Angle	Up to 178° (horizontal and vertical)
Inputs	1x Co-axial RF (ATSC/QAM/NTSC), 2x HDMI™** with HDCP (plus 1x Stereo Audio RCA for DVI source), 2x Component YPbPr plus Stereo Audio, 1x RGB PC plus Stereo Audio, 1x S-Video (AV1) plus Stereo Audio, 2x Composite Video (AV1 & AV2)
Outputs	1x SPDIF Optical Digital Audio (from digital TV only), 1x Analog Audio
Features	PIP, Noise Reduction, CC, V-Chip, 3D Comb Filter, Zoom, Freeze, Motion Adaptive De-Interlace, Picture Enhancement, MPEG-2 Decoding via DTV input, NTSC Video decoding via Video (Composite, S-Video or Component), Progressive Scan Video via HDMI™**, Component or RGB, HDTV via HDMI™**, Component (Set-Top Box required), Computer 640x480, 800x600, 1024x768, 1366x768 via RGB, Sound Enhancement
Speakers	Built-in, 10W x 2
Panel Life	60,000 hours to half the original brightness
Power	
Input	IEC Connector for direct power line connection
Voltage Range	100 ~ 240Vac at 50/60Hz
Power Consumption	210 W max.
Environmental Conditions	
Operating	Temperature: 5°C~35°C, Relative Humidity: 20~80%, Altitude: 0~14,000 ft
Non-Operating	Temperature: -20°C~50°C, Relative Humidity: 10~90%, Altitude: 0~40,000 ft
Dimensions	36.2" W x 26" H x 8.6" D with stand; 36.2" W x 24.9" H x 4.3" D without stand
Net Weight	42.8 lbs with stand
Gross Weight	54.1 lbs
Certifications	CSA/C-UL, FCC Class B

\*Product specifications may change without notice or obligation.



## 6.2 Glossary - Standard Definitions

**Analog TV:** Today's TV system using radio frequency waves to transmit and display pictures and sound.

**Aspect Ratio (4x3):** Traditional TV "aspect ratio", that is, the screen's width as compared to its height. For example, a "32 inch TV screen" would be 25 inches wide and 19 inches tall.

**Aspect Ratio (16x9):** "Wide screen TV" aspect ratio which is more like a movie screen than a traditional TV. For example, a "32 inch TV screen" would be 28 inches wide and 16 inches tall.

**Digital TV (DTV):** Television delivered and displayed using radio frequency waves that contain information that is digitally encoded for improved quality and efficiency.

**Enhanced Definition TV (EDTV):** A better digital television transmission than SDTV with at least 480P, in a 16x9 or 4x3 display and Dolby digital surround sound. 480P is the quality used by most DVD players. EDTV provides 300-400,000 pixels.

**HDTV Monitor (sometimes called HDTV Ready):** A set that can display HDTV programming if you have a separate HDTV tuner, HD Cable Set-Top Box or HD Satellite Set-Top-Box Receiver.

**HDTV Tuner (also decoder, receiver, set-top box):** A device capable of receiving and outputting HDTV signals for display. It may be stand-alone or integrated in the set.

**High-Definition Television (HDTV):** The best quality picture, wide screen (16x9) display with at least 720 progressively scanned lines (720P) or 1080 interlaced lines (1080i) and Dolby digital surround sound. HDTV provides 900,000-2.1 million pixels.

**Integrated HDTV:** An HDTV that has the digital tuner built into the set. It does not need a separate set-top box to receive over-the-air DTV signals.

**Interlace Scan:** A way to scan vertical lines onto a TV picture by scanning all the odd lines first, then filling the in the even lines (this happens instantaneously).

**Plug-and-Play or Digital Cable Ready:** A DTV or other device for digital cable consumers that plugs directly into the cable jack and does not require a separate set-top box. Plug-and-Play TV owners must obtain a CableCARD from their cable company in order to view scrambled programming services.

**Progressive Scan:** A way to scan vertical lines onto a TV picture by scanning all the lines consecutively (progressively).

**Standard Definition TV (SDTV):** Basic digital television transmission that may be displayed with fewer than 480 progressively scanned lines (480P) in 16 x 9 or 4 x 3 format. 480 interlaced (480i) is the quality of today's analog TV system.

Source: Buying a Digital Television, CEA, HDTV Guide, 2005

**Note:** The Federal Communications Commission (FCC), the Consumer Electronics Association (CEA) and the Consumer Electronics Retailers Coalition (CERC) have made a new tip sheet available for digital television (DTV) retailers to reproduce and distribute to consumers on the sales floor. The file may be downloaded online at [www.dtv.gov](http://www.dtv.gov). While you're there, check out the other useful information in the FCC is making available to consumers interested in learning more about the analog to digital transition.



## 6.3 Index

### A

- Accessories, 4
- Adjustments
  - Closed Caption, 11
  - Selecting the Screen Size, 27, 46, 54
  - Selecting the Screen Size, 11
  - Stepping through TV Channels, 27
  - Volume, 8, 27, 49
- Advanced Video Features
  - Adaptive Luma, 33
  - Black Level Extender, 33
  - CTI (Color Transient Improvement), 33
  - DNR (Dynamic Noise Reduction), 33
  - Flesh Tone, 33
  - White Peak Limiter, 33

### C

- Cleaning your VIZIO TV, 49
- Coax (RF)
  - Connecting for DTV, 21
  - Connecting for TV, 22
  - Connecting your Basic Set Top Box, 20
- Component
  - Connecting your DVD Player, 15
  - Connecting your HDTV Set-Top Box, 19
- Composite (AV)
  - Connecting your Basic Set-Top Box, 20
  - Connecting your DVD Player, 16
- Controls
  - Front Panel, 8
  - Side Panel, 8

### D

- DTV
  - Audio Adjustment, 34
  - Parental Control, 38
  - Picture Adjustment, 30
  - Special Features, 36
  - Tuner Setup, 35
- DTV Audio Adjust
  - Balance, 34
  - Bass, 34
  - Simulated Surround Sound, 35
  - Speakers On/Off, 35
  - Treble, 34
  - Volume, 34
- DTV Picture Adjust
  - Advanced Video, 33
  - Backlight, 30, 43
  - Brightness, 31, 43
  - Color, 31
  - Color Temperature, 32, 44
  - Contrast, 31, 44
  - Picture Mode, 30

- Sharpness, 32
- Tint, 31
- DTV Special Features
  - Closed Caption, 36
  - Closed Caption Style, 37
  - Language, 36
  - Reset, 37
  - Sleep Timer, 36
- DTV Tuner Setup
  - Auto Search, 35
  - Daylight Saving, 36
  - Skip Channel, 35
  - Time Zone, 36
  - Tuner Mode, 35
- DVI
  - Connecting your DVD Player, 14
  - Connecting your HDTV Set-Top Box, 18

### E

- Extended Warranty, 59

### G

- Glossary, 54

### H

- HDMI
  - Connecting your DVD Player, 14
  - Connecting your HDTV Set-Top Box, 17
- HDMI Input
  - Audio Adjustment, 41
  - Picture Adjustment, 41
  - Setup, 41

### I

- Inputs
  - Antenna, 3
  - Connectors, 13
  - Rear Label, 9
- Installation
  - Base removal, 5
  - Preparation, 5
  - Safety Instructions, 2
  - Wall Mounting, 5, 24

### O

- OSD
  - Brightness Adjustment, 53
  - Closed Caption Selection, 11
  - Color Adjustment, 13
  - Contrast Adjustment, 53



## P

- Parental Control
  - Block Unrated Programming, 40
  - Channel Block, 38
  - Movie Rating, 39
  - Password change, 40
  - TV Rating, 39
- PC Input
  - Audio Adjustment, 45
  - Picture Adjustment, 24
  - Setup, 45
- PC Picture Adjust
  - Auto Adjust, 43
  - Fine Tune, 45
  - Horizontal Position, 45
  - Horizontal Size, 45
  - Vertical Position, 45
- PC Resolutions, 23
- PIP and POP Inputs, 47

## R

- Remote
  - Batteries, 12
  - Layout, 10, 12
  - Range, 12
- Remote Control
  - Setting the Sleep Timer, 48
  - Using your Cable or Satellite Remote to Operate your VIZIO TV, 48
- RGB
  - Connecting your PC, 23

## S

- Screen Size explanation, 46
- S-Video
  - Connecting your DVD Player, 16
  - Connecting your VCR, 21
  - Connecting your Video Camera, 21

## T

- Technical Specifications, 53
- Troubleshooting Guide, 49
- TV
  - Audio Adjustment, 34

- Parental Control, 38
- Picture Adjustment, 30
- Special Features, 36
- TV Audio Adjust
  - Balance, 34
  - Bass, 34
  - Simulated Surround Sound, 35
  - Speakers On/Off, 35
  - Treble, 34
  - Volume, 34
- TV Picture Adjust
  - Advanced Video, 33
  - Backlight, 30, 43
  - Brightness, 31, 43
  - Color, 31
  - Color Temperature, 32, 44
  - Contrast, 31, 44
  - Picture Mode, 30
  - Sharpness, 32
  - Tint, 31
- TV Special Features
  - Closed Caption, 36
  - Language, 36
  - Reset, 37
  - Sleep Timer, 36
- TV Tuner Setup, 35
  - Auto Search, 35
  - Skip Channel, 35
  - Tuner Mode, 35

## V

- Video Input
  - Audio Adjustment, 42
  - Parental Control, 43
  - Picture Adjustment, 42
  - Setup, 42

## W

- Warranty, 59
- Watching TV
  - Basic Adjustments, 27
  - Basic connections, 24
  - First Startup, 24
  - Getting your Programs, 27
  - Program Information, 28
  - Status Information, 28





## 6.4 Limited Product Warranty

Please read this warranty card carefully, it is a “ONE-YEAR LIMITED WARRANTY” on parts and labor and is only valid when purchased from an Authorized Reseller, only on new and non-refurbished product, and available to customers in the Continental US, Alaska, Hawaii and Puerto Rico. See below for the VIZIO Extended Service warranty.

### VIZIO's Responsibility

VIZIO Displays purchased in the United States are warranted to be free from defects in materials or workmanship for a period of one (1) year from the date of their original retail purchase. If the unit fails to conform to this warranty, we will service the monitor using new or refurbished parts.

### Service Labor

During a period of one (1) year from the effective warranty date, VIZIO will provide, when needed, service labor to repair a manufacturing defect at its designated Service Center. To obtain warranty service in the United States, you must first call our Customer Support at (714) 668-0588. The determination of service will be made by VIZIO Customer Support. PLEASE DO NOT RETURN YOUR UNIT TO VIZIO WITHOUT PRIOR AUTHORIZATION.

### Parts

New or remanufactured replacements for defective parts will be used for repairs by VIZIO at its designated Service Center for one (1) year from the effective warranty date. Such replacement parts are warranted for the remaining portion of the original warranty period.

### Service

During the one (1) year warranty period, VIZIO will, at its option and sole discretion, repair or replace defective parts, including replacement of the entire Panel. The Customer will be required to ship the unit to the Service Center indicated at the time Customer Support is contacted to make the necessary repairs, you are responsible for all transportation charges to and from the service facility. VIZIO is not responsible for the de-installation or re-installation of the unit.

### Packaging and Shipping Instruction

When you send the product to an authorized VIZIO service facility you must use the original carton box and packing material or an equivalent as designated by VIZIO

### Not Covered

This warranty does not cover defects, malfunctions or failures resulting from shipping or transit accidents, abuse, misuse, operation contrary to furnished instructions, operation on incorrect power supplies, operation with faulty associated equipment, modification, alteration, improper servicing, tampering or normal wear and tear or TVs on which the serial number has been removed or defaced. Image Sticking caused by operating at excessive brightness levels for extended periods or mishandling are not covered by this warranty.

ANY IMPLIED WARRANTIES, INCLUDING ANY IMPLIED WARRANTY OF MERCHANTABILITY AND FITNESS FOR A PARTICULAR PURPOSE SHALL BE LIMITED IN DURATION TO THE PERIOD OF TIME SET FORTH ABOVE. OUR LIABILITY FOR ANY AND ALL LOSSES AND DAMAGES RESULTING FROM ANY CAUSE WHATSOEVER, INCLUDING OUR NEGLIGENCE, ALLEGED DAMAGE OR DEFECTIVE GOODS, WHETHER SUCH DEFECTS ARE DISCOVERABLE OR LATENT, SHALL IN NO EVENT EXCEED THE PURCHASE PRICE OF THE DISPLAY. WE SHALL NOT BE RESPONSIBLE FOR LOSS OF USE, COMMERCIAL LOSS OR OTHER INCIDENTAL OR CONSEQUENTIAL DAMAGES. SOME STATES DO NOT ALLOW LIMITATIONS ON HOW LONG AN IMPLIED WARRANTY LASTS OR THE EXCLUSION OR LIMITATION OF INCIDENTAL OR CONSEQUENTIAL DAMAGES, SO THE ABOVE LIMITATIONS OR EXCLUSIONS MAY NOT APPLY TO YOU. This warranty gives you specific legal rights, and you may also have other rights which vary from state to state. This is the only warranty applicable; no one is authorized to extend or modify it or to grant any other warranty.

VIZIO retains the right to assess all warranty claims and to determine if damages are covered by the warranty. In case of a claim that is not covered by the warranty, you will be contacted to determine whether VIZIO should repair the damage for a fee or whether the product should be returned to you as received by the repair center.

### Owner's Responsibility

#### Effective Warranty Date

Warranty begins on the date of sale to the end user. To ensure warranty service, keep the dated bill or sale receipt as evidence of the purchase date.

### Warranty Service

For warranty service information, contact VIZIO Customer Support at (714) 668-0588, 7:30 am to 5:30 pm PST or visit [www.VIZIO.com](http://www.VIZIO.com). Parts and service labor that are VIZIO's responsibility (see above) will be provided without charge. Other service is at the owner's expense. You must provide the model, serial number and date of purchase. Before you ask for warranty service, read your User Manual. You might avoid a service call.

Warranty conditions are subject to change, for latest Warranty Terms and Conditions and additional information regarding your warranty, please see complete details online at [www.VIZIO.com](http://www.VIZIO.com).

### 6.4.1 VIZIO Extended Service Warranty

Protect your investment beyond the standard warranty and experience piece of mind with VIZIO's Extended Service Warranty. Depending on your model, plans are offered for 2-5 years. Visit [www.VIZIO.com](http://www.VIZIO.com) or call 1-800-988-4196 to purchase a plan today.

